

**This Instrument Prepared By  
And Should Be Returned To:**  
Lynda R. Aycock, Esquire  
Rogers Towers, P.A.  
1301 Riverplace Blvd., Suite 1500  
Jacksonville, FL 32207

**COOPY**  
**DECLARATION OF COVENANTS, CONDITIONS,  
RESTRICTIONS AND EASEMENTS FOR  
COUNTRYWALK**  
**THIS DECLARATION**, made this day of 30<sup>th</sup> day of October, 2007, by

**COUNTRYWALK, LLC**, a Florida limited liability company, whose mailing address is P.O. Box 7779, Jacksonville, Florida 32238 (hereinafter called "Developer").

**RECITALS**

A. Developer intends to develop a residential community generally known as COUNTRYWALK upon the real property (the "Property") located in St. Johns County, Florida, and more particularly described in Exhibit "A" attached hereto and made a part hereof.

**COOPY**  
B. Homes within the Property shall be single-family detached dwellings and shall be developed and maintained as part of a residential development of superior quality, architectural design and condition.

C. Developer desires to maintain the beauty of the Property, to assure high-quality standards for the enjoyment of the Property, and to promote the health, safety and social welfare of each Owner of a portion of the Property. To provide for the preservation, enhancement and maintenance of the Property and the improvements thereon, Declarant desires to subject the Property to the covenants, restrictions, easements, charges and liens of this Declaration, each and all of which is and are for the benefit of the Property and each Owner of a portion thereof.

**COOPY**

D. Developer desires to reserve the right to subject all or any portion of any real property in the general geographical vicinity of the Property owned by the Developer or an Affiliate (the "Additional Property"), to the covenants, conditions and restrictions contained herein by annexation of additional real property hereto in accordance with the terms hereinafter set forth.

E. To provide for the efficient management of the Property, Developer deems it desirable to create a nonprofit association. The "Association", as hereinafter defined, shall own, operate, maintain and administer all of the common areas and administer and enforce the covenants, conditions, restrictions and limitations hereinafter set forth. The Association shall also have the power and duty to administer and enforce the easements set forth in this Declaration, and to collect and disburse the assessments hereinafter created.

**DECLARATION**

**NOW, THEREFORE,** Developer hereby declares that the Property and such of the Additional Property that is or may be subsequently encompassed by this Declaration as hereinafter set forth, is and shall be held, sold and conveyed subject to the following easements, restrictions, covenants, limitations and conditions, which are for the purpose of protecting the value and desirability of, and which shall run with, the Property and be binding upon all parties having any right, title or interest in the Property or any part thereof, their heirs, successors and assigns, and shall inure to the benefit of each Owner thereof, including Developer. The previous sentence to the contrary notwithstanding, no part of the Additional Property shall be burdened by this Declaration unless and until such Additional Property is annexed to this Declaration as provided herein.

ARTICLE I

DEFINITIONS

The following definitions shall apply wherever the capitalized terms appear in this

Declaration:

(a) "Affiliate" shall mean and refer to any entity in which the Developer or any of its members or officers, individually or collectively, has a fifty percent or greater ownership interest.

(b) "Annexation" shall mean and refer to the addition of all or any part of the Additional Property, at the option of Developer, to the development community created herein and the subjection of such property to the terms and conditions set forth in this Declaration or such other, further or different terms and conditions as Developer may elect. Annexation shall be accomplished by the recording by Developer of an amendment to this Declaration in the public records of St. Johns County, Florida, describing the property to be annexed along with a plat or legal description of such property.

(c) "ARB" shall mean and refer to the Architectural Review Board as provided in Article VI hereof. The members of the ARB shall be appointed by the "Board of Directors." The ARB shall consist of at least three (3) members.

(d) "Association" shall mean and refer to CountryWalk Owners Association, Inc., a Florida not-for-profit corporation, its successors and assigns. The Articles of Incorporation and Bylaws for the Association shall be referred to as the "Association Articles of Incorporation" and the "Association Bylaws," respectively. Copies of the Association Articles of Incorporation and Association Bylaws are attached as Exhibits "B" and "C", respectively. The Association shall own, operate and maintain the Common Areas; enforce the easements set forth in this

Declaration; collect and disburse the assessments hereinafter created; and be responsible for the administration and enforcement of the covenants, conditions, restrictions and limitations hereinafter set forth (sometimes referred to as the "covenants and restrictions").

(e) "Association Rules and Regulations" shall mean and refer to the rules, regulations and policies adopted by the Board of Directors as the same may be amended from time to time. The Association Rules and Regulations shall not contradict the terms and conditions of this Declaration, as amended from time to time.

(f) "Board of Directors" shall mean and refer to the Board of Directors of the Association.

(g) "Charges" shall mean and include all General, Special and Lot Assessments.

(h) "Common Area" or "Common Areas" shall mean and refer to all real and personal property now or hereafter owned by the Association, which is intended for the common use and enjoyment of all of the owners within the Property. The Common Areas may include, without limitation, the Stormwater Retention System, irrigation systems in the Common Areas, Swimming Pool, Clubhouse, Gazebo, Tot Lot, walkways, street lighting, entry features and signage, lakes, ponds and watercourses, access, utility and drainage easements and related facilities. The Common Area initially designated by the Developer shall consist of the real property (and interests therein) more particularly described on Exhibit "D" attached hereto and made a part hereof together with all improvements constructed therein by Developer, but not owned or maintained by a public or private utility company.

(i) "Developer" shall mean and refer to **COUNTRYWALK, LLC**, a Florida limited liability company, or such other entity owning all or a portion of the "Property" which has been specifically assigned the rights of Developer hereunder and any assignee thereof which has had

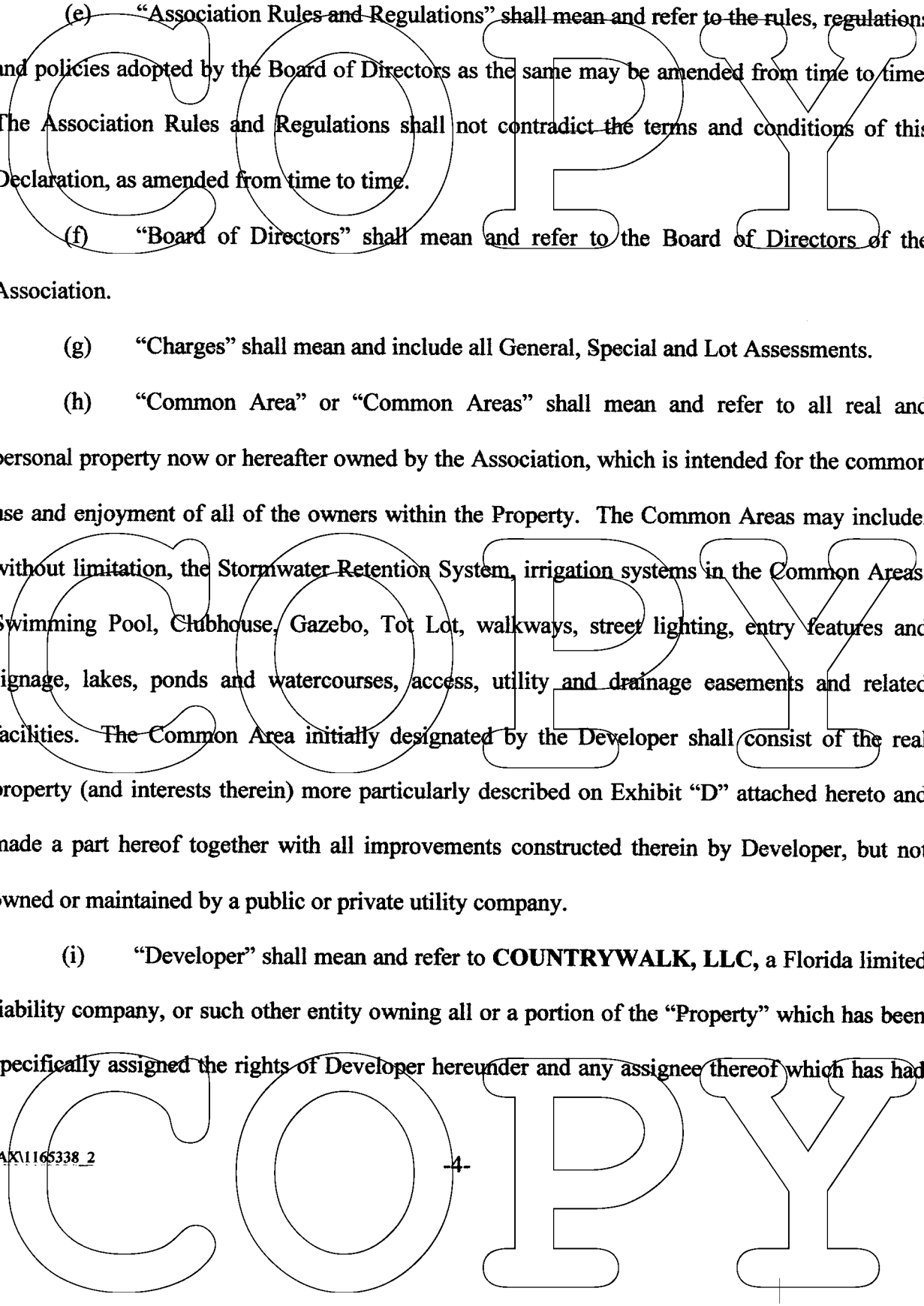

the rights of Developer similarly assigned to it. The Developer may also be an Owner for so long as the Developer shall be record owner of any Lot as defined herein.

(j) "Declaration" shall mean and refer to this Declaration of Easements, Covenants, Conditions, Restrictions and Easements for CountryWalk applicable to the Property.

(k) "Family" shall mean to include a spouse, children, parents, brothers, sisters, grandchildren and other persons permanently cohabiting the House as or together with the Owner or permitted occupant thereof.

(l) "General Assessment" shall mean and refer to an assessment required of all Owners, as further provided in Article V entitled "Covenants for Maintenance Assessments" and elsewhere in this Declaration.

(m) "Guest" shall mean and refer to a social guest of an Owner. However, any person residing on any portion of the Property for a period of sixty (60) consecutive days or longer shall be deemed a permanent resident.

(n) "House" shall mean and refer to any single-family residential dwelling constructed or to be constructed on or within any Lot.

(o) "Lot" shall mean and refer to any plot of land intended as a site for a House, whether or not the same is then shown upon any duly recorded subdivision plat of the Property. Upon construction of a House, the term "Lot" as used herein shall include the House and Yard.

(p) "Lot Assessment" shall mean and refer to any assessment charged to a particular Owner pursuant to this Declaration for services and costs which relate specifically to that Owner's Lot.

JAX1165338\_2 -5- COPY

(q) "Member" shall mean and refer to those persons entitled to membership in the Association as provided in this Declaration or the Association Articles of Incorporation and Association Bylaws.

(r) "Mortgage" shall mean any bona fide first mortgage encumbering a Lot as security for the performance of an obligation.

(s) "Mortgagee" shall mean and refer to any institutional holder of a Mortgage, such as a bank, savings and loan association, insurance company, or any other lender generally recognized as an institutional type lender.

(t) "Owner" shall mean and refer to the record owner, whether one or more persons or entities, of the fee simple title to any Lot. Owner shall not include those having an interest merely as security for the performance of an obligation. In the event that there is a contract for deed covering any Lot, the Owner of such parcel shall be the purchaser under said contract, and not the fee simple title holder. The contract for deed is defined as an agreement whereby the purchaser is required to make periodic payments toward the purchase of a Lot for a period extending beyond nine (9) months from the date of the agreement, and where the purchaser does not receive title to such Lot until all periodic payments are made, but is given the use and possession of the Lot prior to such acquisition of title.

(u) "Property" shall mean and refer to that certain real property described in Exhibit "A".

(v) "Special Assessments" shall mean and refer to those Special Assessments referred to in Article V hereof.

(w) "Stormwater Retention System" shall mean lakes, lake underdrain systems, lake control structures, underground drainage pipes and other drainage structures which are designed

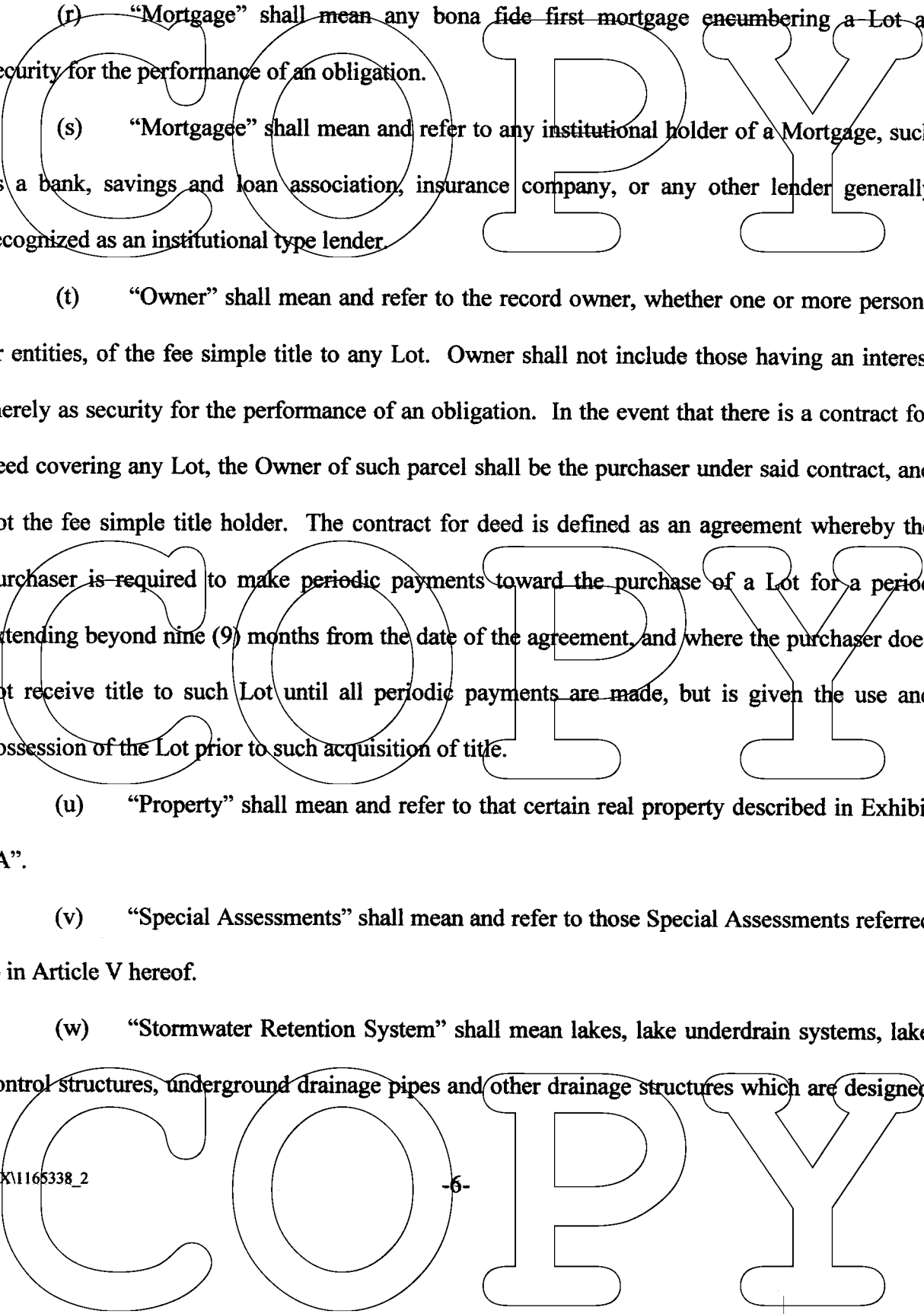

to accept and detain stormwater from the Property and constructed on the Property pursuant to and in a manner consistent with the St. Johns River Water Management District Permit No. #4-109-905-37-2.

(x) "Yard" shall mean and refer to any and all portions of any Lot lying outside the exterior walls of any House constructed on such Lot and shall include all landscaping, improvements and decorative and functional appurtenances thereon.

**ARTICLE II**  
**OWNERSHIP AND MEMBERSHIP**

**Section 1.** A Lot may be owned by one or more natural persons or an entity other than a natural person.

**Section 2.** Every Owner shall be a Member of the Association. Membership shall be appurtenant to and may not be separated from title to any Lot except as provided for herein.

**Section 3.** The Association shall have two classes of voting membership:

(a) **Class A.** Class A Members shall be all Owners with the exception of the Developer while the Developer is a Class B Member. Class A Members shall be entitled to one vote for each Lot owned. When more than one person holds an interest in any Lot, other than as security for the performance of an obligation, all such persons shall be Members. The vote for such parcel shall be exercised as they, between themselves, determine, by written designation to the Association, but in no event shall more than one vote be cast with respect to any Lot. The vote appurtenant to any Lot shall be suspended in the event that, and for as long as, more than one member holding an interest in that Lot lawfully seeks to exercise it.

(b) **Class B.** Class B Members shall be the Developer, who shall be entitled to the number of votes equal to the number of votes held by all Class A Members, plus one. The

Class B membership shall cease upon the occurrence of the earlier of the following events ("Turnover"):

(i) Three months after ninety percent (90%) of the Lots in the Property that will ultimately be operated by the Association have been conveyed to Class A Members;

(ii) Such earlier date as Developer, in its sole discretion, may determine in writing, but in no event later than 10 years after recording this Declaration.

**Section 4.** All votes shall be exercised or cast in the manner provided by this Declaration and the Bylaws. After Turnover, the Class A Members may vote to elect the majority of the members of the Board of Directors of the Association. For the purposes of this Article II, builders, contractors or others who purchase a Lot for the purpose of constructing improvements thereon for resale shall not be deemed to be Class A Members. After Turnover, for so long as the Developer owns at least five percent (5%) of the Lots within the Property, the Developer may appoint the minority of the Board of Directors of the Association or not less than one (1) director. After Turnover, the Developer will be a Class A Member with respect to the Lots which it owns and shall have all rights and obligations of a Class A Member, except that it may not cast its votes for the purpose of reacquiring control of the Association.

**ARTICLE III**

**OWNER'S RIGHTS**

**Section 1.** Every Owner shall have a right and easement of enjoyment in and to the Common Area, which will be appurtenant to and shall pass with title to every Lot, subject to the provisions of the Association Articles of Incorporation, Bylaws and Rules and Regulations and the following provisions:

(a) The right of the Association to charge assessments and other fees for the maintenance and security of the Common Areas and the facilities and services provided Owners as described herein.

(b) The right of the Association to adopt rules and regulations governing the manner and extent of use of the Common Areas and the personal conduct of the Members of the Association and their guests thereon.

(c) The right of the Association to dedicate or transfer all or any part of the Common Areas to any public agency, authority or utility (public or private) for such purposes and subject to such conditions as may be agreed upon by the Members of the Association.

(d) The right of the Association to mortgage any or all of the facilities constructed on its property for the purpose of improvements or repair to such property or facilities provided such action is approved by majority at a regular meeting of the Association or at a special meeting called for this purpose.

(e) The right of Developer or the Association to grant and reserve easements and rights-of-way through, under, over and across the Common Areas.

(f) The right of Developer or the Association to acquire, extend, terminate or abandon easements.

(g) The right of the St. Johns River Water Management District to enforce rules and regulations with regard to the Stormwater Retention System.

**Section 2.** Any Owner may assign his right of enjoyment to the Common Areas and facilities thereon to his tenant who resides on his Lot, subject to the provisions of this Declaration and the Association Articles of Incorporation, Bylaws and Rules and Regulations.

JAX1165338\_2 -9- COPY

**Section 3.** In the event any Common Areas, facilities or personal property of the Association or of Developer are damaged or destroyed by an Owner or any of his Guests, tenants, licensees, agents, employees or members of his Family as a result of negligence or intentional acts, such Owner does hereby authorize the Association to repair the damage. Such repairs will be performed in a good and workmanlike manner in conformance with the original plans and specifications for the area involved or as the area may have been modified or altered subsequently by the Association. The amount necessary for such repairs shall be the responsibility of such Owner and shall become a Lot Assessment.

**Section 4.** Developer may retain title to the Common Areas, or any portion thereof, until such time as it has completed all improvements thereto. Upon such completion, Developer hereby covenants that it will convey the Common Areas to the Association subject to easements and restrictions of record and free and clear of all liens and financial encumbrances other than taxes for the year of conveyance. Developer shall reserve the right, after conveyance to the Association, to enter upon such Common Areas for the purpose of construction of additional facilities, alteration of existing facilities, landscaping or creation of new easements or modifications of pre-existing easements, or to exercise any other rights provided for elsewhere herein. Each Owner's obligation to pay assessments, as provided herein, shall commence when the Lot owned by the Owner has been substantially developed, notwithstanding that the Common Areas have not then been conveyed to the Association. For purposes hereof, a Lot shall be deemed "substantially developed" when all roads necessary to provide access to that particular Lot have been constructed, and utilities for use by the Owner of the particular Lot are in place and ready for connection.

**Section 5.** No Lot upon which a House has been constructed shall be further subdivided or separated into smaller lots by any Owner; provided that this shall not prohibit corrective deeds, or similar corrective instruments. Developer shall have the right to modify subdivision plats of the Property if all Owners to whom Lots from such plat have been conveyed consent to such modification, which consent shall not be unreasonably withheld.

COPY

**ARTICLE IV**  
**ASSOCIATION**

**Section 1.** The duties and powers of the Association shall be those provided for by law or set forth in this Declaration, the Association's Articles of Incorporation and the Association's Bylaws, together with those duties and powers which may be reasonably implied to effect the purposes of the Association. Without limiting the generality of the foregoing, the Association shall take such measures and perform such services which in the judgment of the Board of Directors are necessary or desirable to enforce the covenants, conditions, restrictions and limitations set forth in this Declaration; operate, maintain and administer all Common Areas and the Stormwater Retention System within the Property in accordance with all applicable governmental rules, regulations and permits, including, without limitation, all permits and rules and regulations issued by the St. Johns River Water Management District; administer and enforce the easements provided for in this Declaration; and collect and disburse the assessments created in this Declaration.

COPY

**Section 2.** It shall be the obligation of each Owner to maintain his Lot in a neat, clean and attractive condition. In the event an Owner fails to do so, the Association shall have the right to clean up the Lot, cut weeds, and do such things as it may deem necessary and appropriate. The costs incurred by the Association for such Lot maintenance shall be a Lot

COPY

Assessment. If construction of a House on any Lot has not begun within three (3) years after conveyance of that Lot by Developer, the Association may install an irrigation system, plant grass and maintain the Lot to provide a finished appearance. The costs of these services shall be a Lot Assessment.

**Section 3.** Except as provided for herein, the Association is not responsible for any exterior maintenance of Houses, including but not limited to, glass surfaces on doors, screens and screen doors, exterior doors and window fixtures, terraces, patio and deck improvements or roofs.

**Section 4.** The Association may employ or contract with one or more third parties for the performance of all or any portion of the Association's management, maintenance and repair activities, as the Association Board of Directors may choose. The Association shall be billed by its independent contractors, and the cost therefor shall be included within the General Assessment or Lot Assessment, as the case may be.

**Section 5.** The Association may, but shall not be required to, establish security procedures for the Property. Such procedures may be adopted and from time to time changed by the Association as the Association Board of Directors chooses in its discretion. No representation, guarantee or warranty is made, nor assurance given, that the security systems or procedures for the Property will prevent personal injury or damage to or loss of property. Neither Developer nor the Association nor its Board of Directors or other agents shall be liable or responsible for any personal injury or for any loss or damage to property which may occur within the Property, whether or not it is due to the failure of the security system and procedures adopted from time to time.

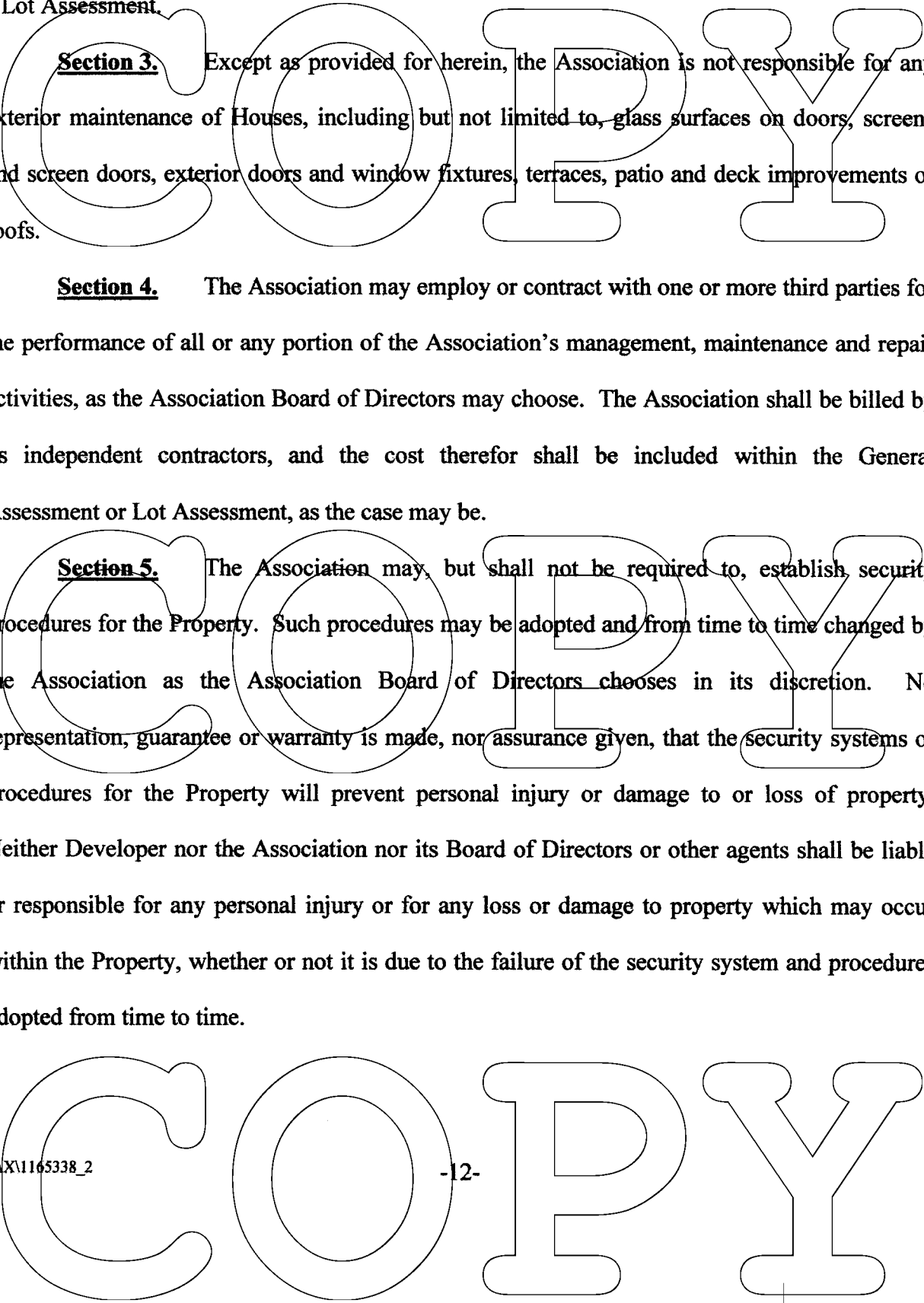

**ARTICLE V**

**COVENANTS FOR MAINTENANCE ASSESSMENTS**

**Section 1.** All assessments and fines (referred to collectively in this Article as “charges”), together with interest and costs of collection when delinquent, shall be a charge on the land and shall be a continuing lien upon the Lot against which the charges are made, and shall also be the personal obligation of the person or entity who is the Owner of such Lot at the time when the charges were levied, and of each subsequent Owner. Each Owner of a Lot, by acceptance of a deed or other transfer document therefor, whether or not it shall be so expressed in such deed or transfer document, is deemed to covenant and agree to pay the Association the charges established or described in this Article and in the Association Articles of Incorporation and Bylaws. No diminution or abatement of any charges shall be allowed by reason of any alleged failure of the Association to perform such function required of it, or any alleged negligent or wrongful acts of the Association, or its officers, agents and employees, or the nonuse by the Owner of any or all of the Common Areas, the obligation to pay such charges being a separate and independent covenant by each Owner.

**Section 2.** Each Lot within the Property is subject to a one-time “Working Capital Contribution” assessment by the Association in the amount of Four Hundred and 95/100 Dollars (\$495.00), which may be used for additional capital improvements or services which were not included in the Developer’s original budget categories for the development of the Property and may be used by the Developer to fund the operating deficit. Such Working Capital Contribution shall be due upon the conveyance of any Lot from the Developer to an Owner.

**Section 3.** Each Lot within the Property is subject to an Annual General Assessment by the Association for the improvement, maintenance and operation of the Property, including

the management and administration of the Association and the furnishing of services as set forth in this Declaration. Such General Assessments must be allocated equally on a per lot basis. As further described in this Article, the Board of Directors of the Association by a majority vote shall set the Annual General Assessments at a level sufficient to meet the Association's obligations. The Association Board of Directors shall have the right, power and authority, during any fiscal year, to increase the Annual General Assessment for the purpose of meeting its expenses and operating costs on a current basis. The Association Board of Directors shall set the date or dates that the Assessments shall become due, and may provide for collection of Assessments annually or in monthly, quarterly or semi-annual installments; provided, however, that upon a default in the payment of any one or more installments, the entire balance of the yearly Assessment may be accelerated at the option of the Association Board of Directors and be declared due and payable in full.

**Section 4.**

(a) In addition to Annual General Assessments authorized above, the Association may levy in any assessment year a Special Assessment for the purpose of defraying, in whole or in part, the cost of any construction, reconstruction, repair or replacement of a capital improvement upon the Common Areas, including fixtures and personal property related thereto, provided that such assessments shall have been properly authorized pursuant to the terms of the Association Articles of Incorporation and Bylaws.

(b) In addition, the Association may levy an Emergency Assessment at any time by a majority vote of the Association Board of Directors, for the purpose of defraying, in whole or in part, the cost of any unusual or emergency matters that affect the Common Areas,

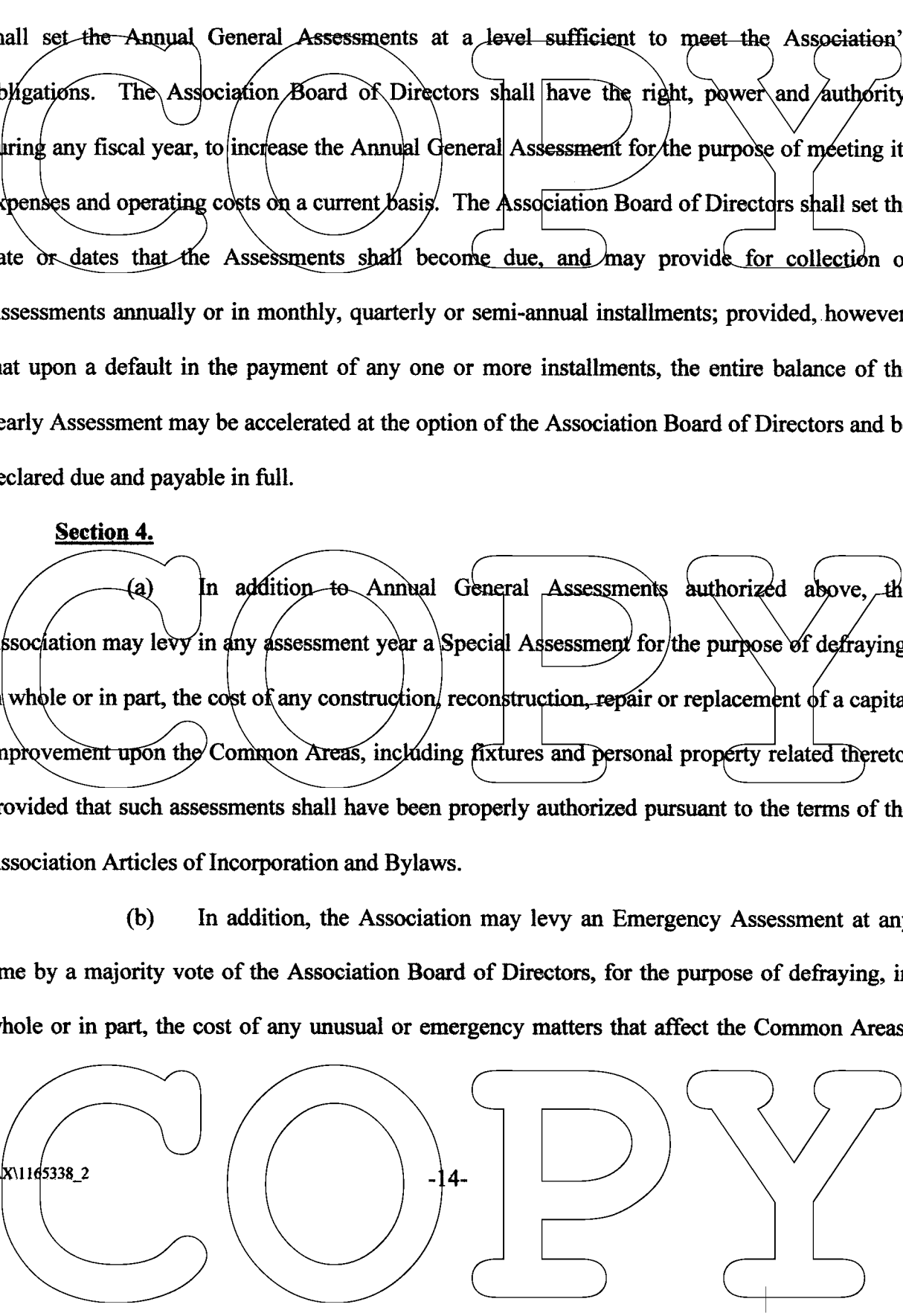

and shall be due and payable at the time and in the manner specified by the Association Board of Directors.

**Section 5.** In addition to the Assessments authorized above, the Association may levy in any assessment year a Lot Assessment against a particular Lot for the purpose of defraying, in whole or in part, the cost of any construction, reconstruction, repair or replacement of a capital improvement upon the specific Lot, or any other maintenance or special services provided to such Lot or its Owner, the cost of which is not included in the General Assessment.

**Section 6.** The Annual General Assessments provided for herein shall commence when the Property has been substantially developed. The initial Assessment on any Lot subject to assessment shall be collected on the first day of the month following the month in which the Lot is deemed substantially developed by the Developer or at the time title to such Lot is conveyed to an Owner, whichever is latest to occur. During the initial year of ownership, each Owner shall be responsible for the prorata share of the General or Special Assessments charged to that Owner's lot, prorated to the date of closing based upon a thirty-day month.

**Section 7.**  
(a) Any charges not paid within fifteen (15) days after the due date shall be subject to a late fee as determined from time to time by the Association Board of Directors and shall bear interest at a rate of eighteen percent (18%) per annum until paid.

(b) All charges against any Lot pursuant to this Declaration, together with such late fee, interest thereon, and cost of collection thereof (including reasonable attorney's fees, whether suit is filed or not), shall become a lien on such Lot. The Association may bring an action at law against the Owner personally obligated to pay the same, foreclose the lien against the Lot, or both. Costs and reasonable attorney's fees incurred in any such action shall be

awarded to the prevailing party. The lien provided for in this Section shall be in favor of the Association. The Association, acting on behalf of the Owners, shall have the power to bid for an interest in any Lot foreclosed at such foreclosure sale and to acquire and hold, lease, mortgage and convey the same.

(c) Each Owner, by acquisition of an interest in a Lot, hereby expressly vests in the Association the right and power to bring all actions against such Owner personally for the collection of such charges as a debt and to enforce the aforesaid by all methods available for the enforcement of such liens, including foreclosures, by an action brought in the name of the Association, in a like manner as the mortgage lien on real property, and such Owner hereby expressly grants to the Association a power of sale in connection with such lien. No Owner may waive or otherwise escape liability for the charges provided for herein by abandonment of his Lot.

(d) The lien of the charges provided for herein shall be inferior and subordinate to the lien of a Mortgage held by a Mortgagee now or hereafter placed upon any Lot subject to assessment so long as such Mortgage lien is recorded prior to any claim of lien filed by the Association. Sale or transfer of any Lot shall not affect the charges lien; however, the sale or transfer of any parcel pursuant to foreclosure of such Mortgage, including a transfer by a deed in lieu of foreclosure, shall extinguish the lien of such charges as to payments which became due prior to such sale or transfer.

**Section 8.** The Treasurer of the Association, upon demand of any Owner liable for charges, shall furnish to such Owner a certificate in writing signed by such Treasurer, setting forth whether such charges have been made.

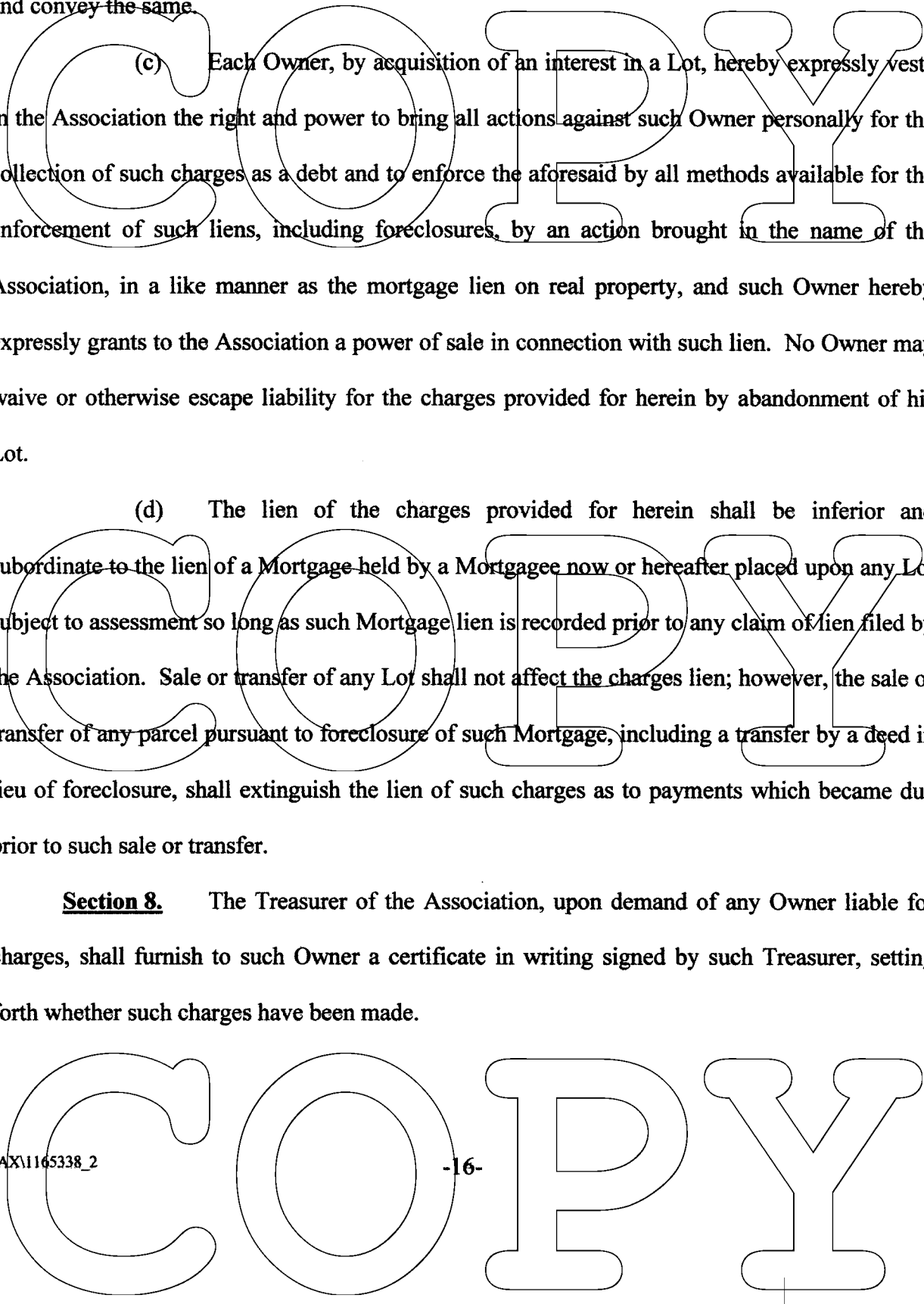

**Section 9. Budget.**

(a) The fiscal year of the Association shall consist of a twelve-month period commencing on January 1st of each year and terminating on December 31st of that year.

(b) ~~Developer shall determine the Association budget for the fiscal year in which a Lot is first assessed its fractional share of the Annual General Assessment.~~

(c) Pursuant to the Association Articles of Incorporation and Association's Bylaws, the Association Board of Directors shall adopt a budget for each succeeding year containing an estimate of the total amount which they consider necessary to pay the cost of all expenses to be incurred by the Association, to carry out its responsibilities and obligations including, without limitation, the cost of wages, materials, insurance premiums, services, supplies and other expenses needed to render the services specified hereunder. Such budget shall also include such reasonable amounts as the Association Board of Directors consider necessary to provide working capital and to provide for a general operating reserve and reserves for contingencies and replacements. The Association Board of Directors shall send each of its Members a copy of the budget, in a reasonably itemized form which sets forth the amount of the Assessments payable by each of its Members. Each budget shall constitute the basis for determining each Owner's General Assessment as provided herein.

(d) The failure or delay of the Association Board of Directors to prepare or adopt the annual budget or adjusted budget for any fiscal year shall not constitute a waiver or release in any manner of any Owner's obligation to pay his Assessment as herein provided, whenever the same shall be determined. In the absence of an annual budget or adjusted budget, each Owner shall continue to pay the Assessment at the then existing rate established for the previous fiscal period in the manner such payment was previously due until notified otherwise.

**Section 10.** During the "Development Period" (as hereinafter defined), the Lots and other portions of the Property owned by Developer shall not be subject to any Assessments levied by the Association or to any lien for such assessments. During the Development Period, and in lieu of payment of any assessments to the Association, Developer shall pay the balance of the actual operating expenses of the Association (excluding the cost of funding deferred maintenance and reserve accounts) remaining after the levying of and payment of assessments due from Owners other than Developer pursuant to assessments levied by the Board pursuant to this Declaration. Developer shall be obligated to fund such balance only as the expenses are actually incurred by the Association during the Development Period. The "Development Period" shall be defined as the period of time beginning upon the conveyance of the first Lot in the Property to an Owner other than Developer and continuing until Developer shall notify the Association that it will no longer pay for operating deficits of the Association. Upon termination of Developer's agreement to pay operating deficits, Developer shall become obligated to pay assessments on Lots owned by it within the Property on the same basis as other Owners. In no event shall Developer be obligated to pay for operating deficits of the Association after Developer no longer owns any Lots within the Property. The Developer may assign this exemption right to any entity that acquires two or more Lots for development purposes. Such an assignment shall have no effect on the Developer's exemption hereunder.

**Section 11.** In the event the Common Areas owned by the Association are taxed separately from the Lots deeded to Owners, the Association shall include such taxes as a part of the budget. In the event the Common Areas owned by the Association are taxed as a component of the value of the Lot owned by each Owner, it shall be the obligation of each Owner to timely pay such taxes.

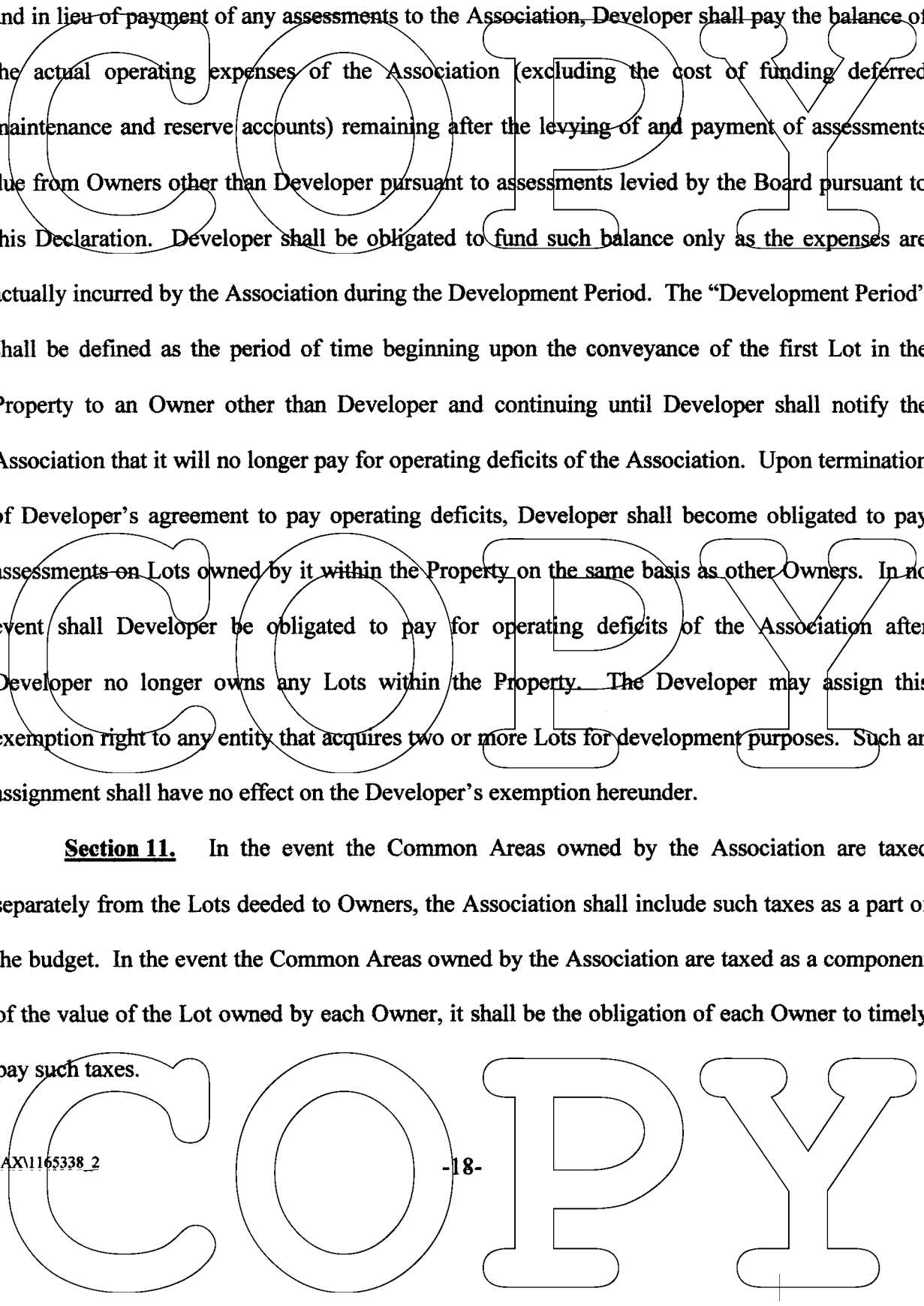

ARTICLE VI

ARCHITECTURAL CONTROL

**Section 1.** In order to preserve the beauty and aesthetic design of the Development and to promote the value of the Development, the Property is hereby made subject to the following restrictions in this Article, and every Lot Owner agrees to be bound hereby.

**Section 2.** The Board of Directors shall establish the Architectural Review Board (the "ARB"), which shall consist of at least three (3) members who may or may not be members of the Board of Directors, provided that prior to the termination of Developer's right to appoint and remove officers and directors of the Association, Developer reserves the right to appoint a majority of the members of the ARB, which appointees do not have to be Owners. Each ARB member shall be appointed for a one (1) year term commencing with the fiscal year of the Association and may be removed, with or without cause, by the Board of Directors at any time by written notice, with successors appointed to fill such vacancy for the remainder of the term of the former member, provided that only Developer shall have the right to remove ARB members which Developer has appointed. The ARB shall meet at least monthly at such places as may be designated by the Chairman of the ARB. A majority of the members shall constitute a quorum for the transaction of business, and the affirmative vote of the majority of those present in person or by proxy shall constitute the action of the ARB on any matter before it. The ARB is authorized to retain the services of consulting architects, landscape architects, urban designers, engineers, inspectors, contractors and/or attorneys in order to advise and assist the ARB in performing its functions as set forth herein.

**Section 3.** No construction, modification, alteration or other improvement of any nature whatsoever, except for interior alterations not affecting the external structure or

appearance of any House, shall be undertaken on any Lot unless and until a plan of such construction or alteration shall have been approved in writing by the ARB. Modifications subject to ARB approval specifically include, but are not limited to, painting or other alteration of a House (including doors, windows and roof); installation of solar panels or other devices; construction of fountains, swimming pools, whirlpools or other pools; construction of privacy fences; construction of boat docks and davits; additions of awnings, shutters, gates, flower boxes, shelves, statues or other outdoor ornamentation; installation of patterned or brightly colored internal window treatments; any alteration of the landscaping or topography of the Lot, including without limitation planting or removal of plants; creation or alteration of lakes, marshes, hammocks, lagoons or similar features of the Property; and all other modification, alterations or improvements visible from Common Areas or other Lots. This Article shall not apply to any portion of the Property while it is being utilized by a governmental entity or being developed by the Developer.

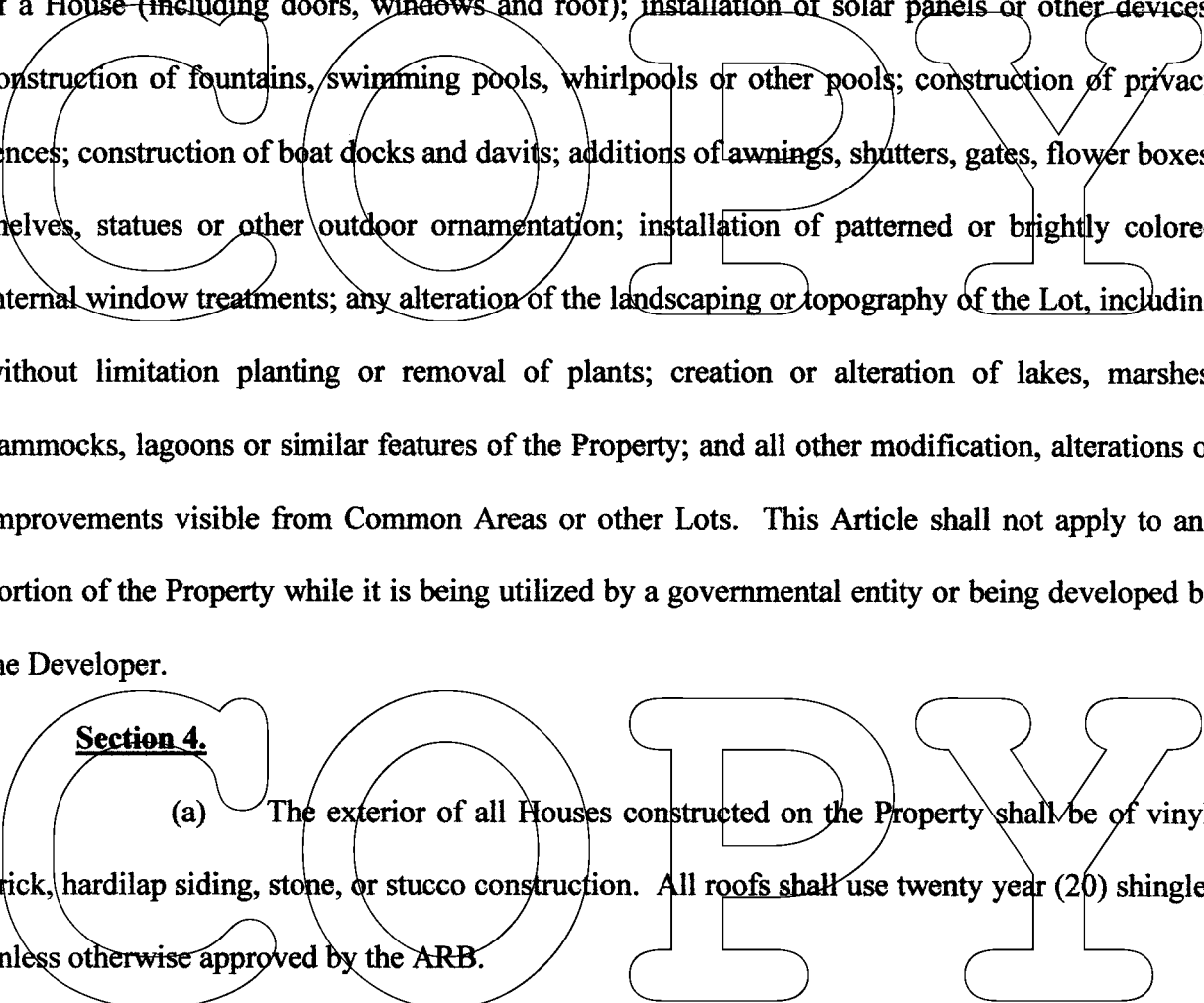

**Section 4.**

(a) The exterior of all Houses constructed on the Property shall be of vinyl, brick, hardilap siding, stone, or stucco construction. All roofs shall use twenty year (20) shingles unless otherwise approved by the ARB.

(b) The plans to be submitted to the ARB for approval shall include (i) two copies of the construction plans and specifications, including all proposed landscaping, (ii) an elevation or rendering of all improvements, (iii) a tree survey of the Lot which shows the proposed location of all improvements, and (iv) such other items as the ARB may deem appropriate. One copy of such plans, specifications and related data so submitted shall be

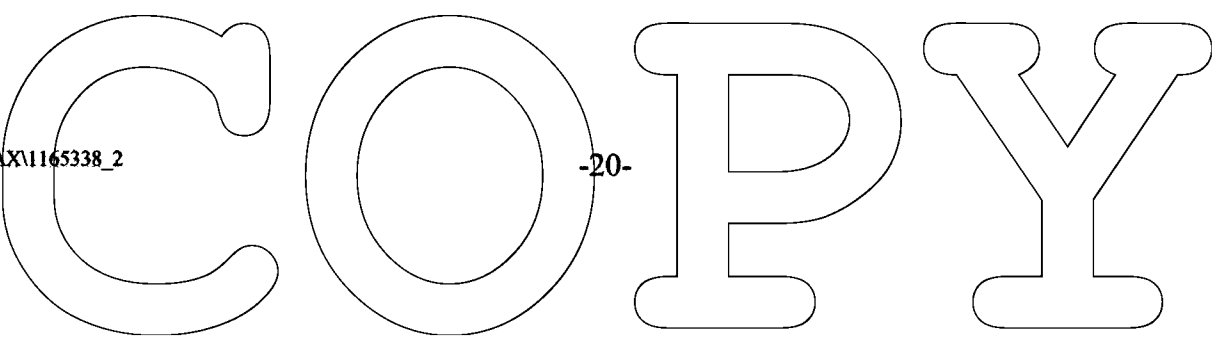

retained in the records of the ARB, and the other copy shall be returned to the Owner marked "Approved" or "Disapproved."

(c) Approval shall be granted or denied by the ARB based upon compliance with the provisions of this Declaration, the quality of workmanship and materials, harmony of external design with surrounding structures, the effect of the improvements on the appearance from surrounding areas, and all other factors, including purely esthetic considerations which, in the sole opinion of the ARB, will affect the desirability or suitability of the construction. The ARB shall have the sole discretion to determine whether plans and specifications submitted for approval are acceptable. In connection with approval rights and to prevent excessive drainage or surface water run-off, the ARB shall have the right to establish a maximum percentage of a Lot which may be covered by dwellings, buildings, structures or other improvements, which standards shall be promulgated on the basis of topography, percolation rate of the soil, soil types and conditions, vegetation cover and other environmental factors. Following approval of any plans and specifications by the ARB, representatives of the ARB shall have the right during reasonable hours to enter upon and inspect any Lot and House, or other improvements, with respect to its construction as underway to determine whether or not the plans and specifications therefor have been approved and are being complied with. In the event the ARB shall determine that such plans and specifications have not been approved or are not being complied with, the ARB in the name of the Association, or any Owner, shall be entitled to enjoin further construction and to require the removal or correction of any work in place which does not comply with approved plans and specifications.

(d) Approval or disapproval of applications shall be given to the applicant in writing by the ARB in accordance with its procedures. In the event that the approval or

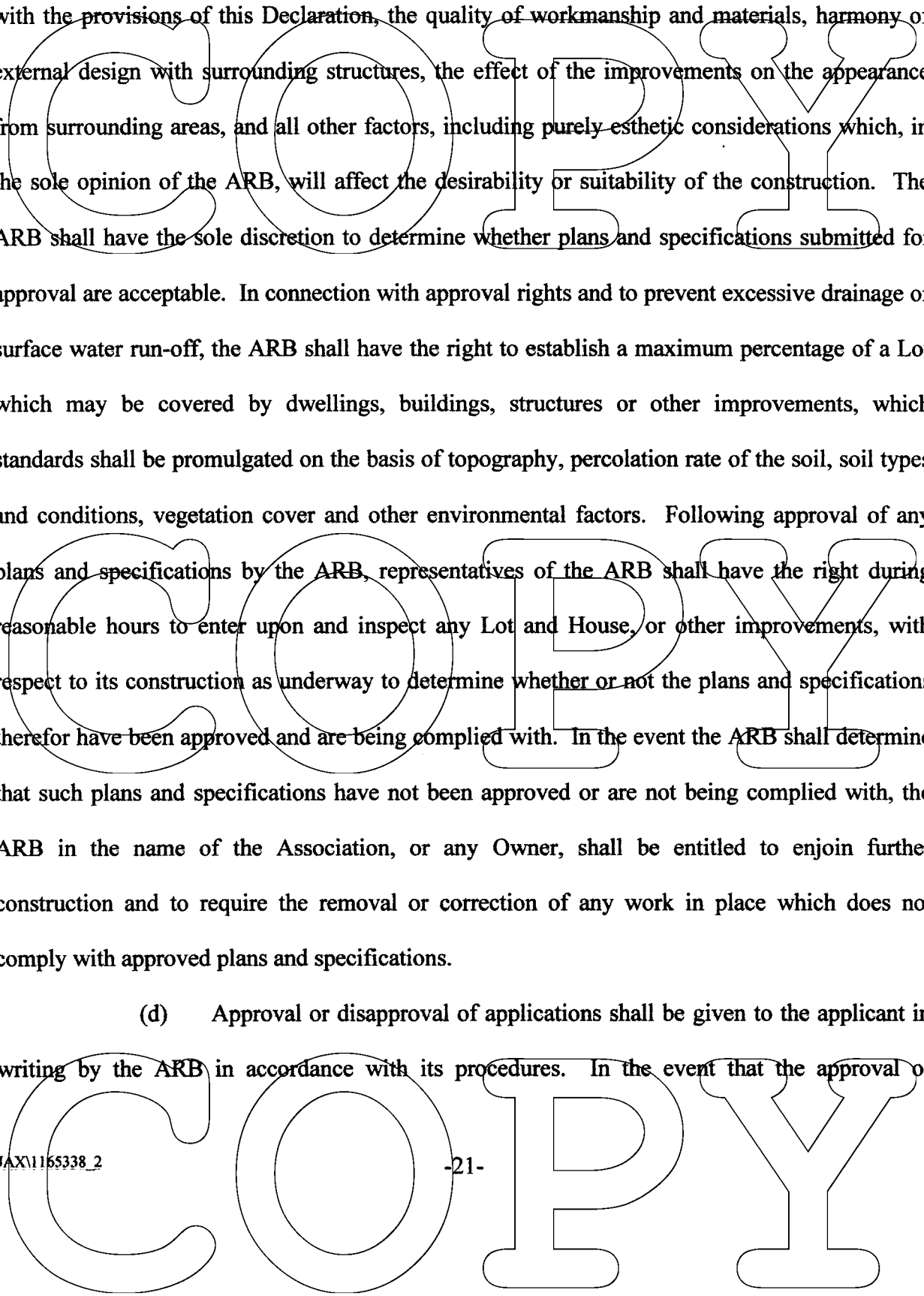

disapproval is not forthcoming within forty-five (45) days after complete submittal has been made to the ARB, unless an extension is agreed to by the applicant, the application shall be deemed approved and the construction of the improvements applied for may be commenced, provided that all such construction is in accordance with the submitted plans, and provided further that such plans conform in all respects to the other terms and provisions of this Declaration.

(e) After approval by the ARB, the proposed improvements must be substantially commenced within six (6) months, or approval must once again be obtained from the ARB as provided herein. Once commenced, the construction must proceed diligently. The exterior of any House and the accompanying landscaping shall be completed within nine (9) months from commencement unless the ARB allows an extension of time.

(f) The ARB shall establish and collect a fee sufficient to cover the expense of reviewing plans and related data and to compensate any consulting architects, landscape architects, urban designers, inspectors or attorneys retained in accordance with the terms hereof. The ARB or Board of Directors shall have the right to increase the amount of this fee from time to time.

**Section 5.** Any Owner may appeal an adverse decision of the ARB to the Board of Directors, who may reverse or modify the decision of the ARB by a majority vote of the Directors. Furthermore, if a House or other improvement has been or is about to be erected on any Lot in such manner as to constitute a minor violation of, or minor variance from, the provisions of this Declaration, the Developer or the Association shall have the right to waive or approve the minor variance or minor violation. The Developer, or the Association, as the case may be, shall have the right in its sole discretion to determine whether a violation or variance is minor.

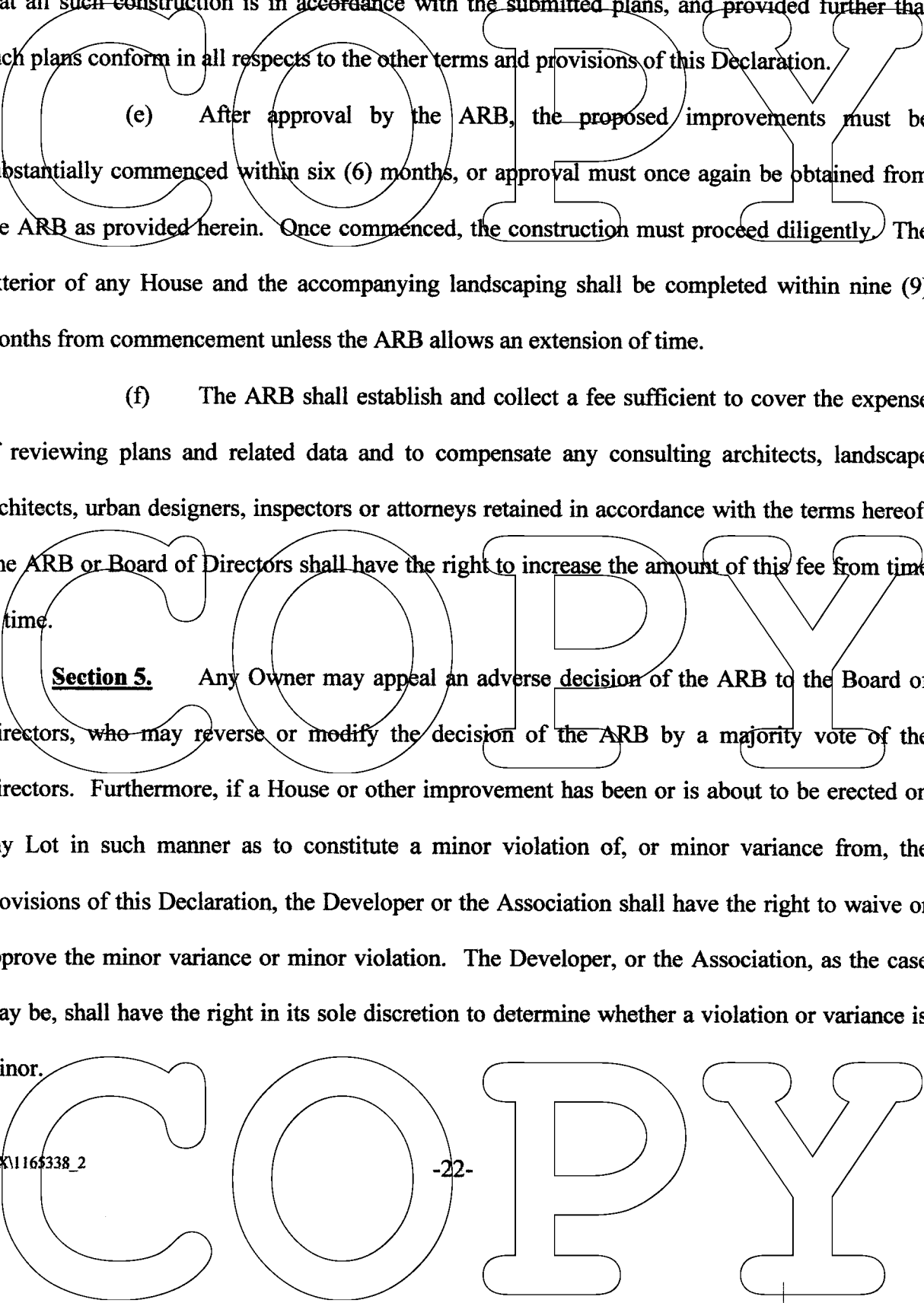

**Section 6.** No approval of plans and specifications and no publication of architectural standards shall be construed as representing or implying that such plans, specifications or standards will, if followed, result in properly designed improvements. Such approvals and standards shall in no event be construed as representing or guaranteeing that any House or other improvement built in accordance therewith will be built in accordance with applicable building codes or other governmental requirements or in a good and workmanlike manner. Neither Developer, the Association nor the ARB shall be responsible or liable for any defects in any plans or specifications submitted, revised or approved pursuant to the terms of this Article, nor any defects in construction undertaken pursuant to such plans and specifications.

**ARTICLE VII**

**USE OF PROPERTY**

**Section 1.** In order to preserve the Property as a desirable place to live for all Owners, the following protective covenants are made a part of this Declaration:

- (a) No modification, alteration or improvement shall interfere with those easements or other rights set forth in this Declaration or on any recorded plat of all or any portion of the Property.
- (b) No House or other structures shall be constructed on a Lot which has a height exceeding 35 feet above the elevation of the finished surface of the first floor of such dwelling. All Houses constructed on Lots shall have a minimum of 1,100 square feet of heated and air conditioned living space.

(c) Each House shall be located on the Lot in the following manner:

- (i) not nearer than twenty feet (20') from the front Lot line;

(ii) not nearer than ten feet (10') from the rear Lot line except any building with a permanent foundation shall be set back a minimum of twenty-five feet (25') from the average width natural vegetative upland buffer adjacent to contiguous wetlands; and

(iii) not nearer than five feet (5') to any side Lot line.

(d) All garbage receptacles, fuel tanks, gas and electric meters, air conditioning equipment, and materials, supplies and equipment which are stored outside must be placed or stored in such a way to conceal them from view of adjacent properties. Any such visual barrier may consist of either fencing or landscaping and planting which is approved by the ARB in accordance with the terms of this Article.

(e) Each Lot not owned by Developer shall be used, improved and devoted exclusively to residential use by one Family. The previous sentence to the contrary notwithstanding, an Owner shall be entitled to maintain an office in his House for personal use only provided (i) the House is the primary residence of the Owner, (ii) such office is not open to customers, clients or members of the general public and (iii) the Owner complies with all laws, rules and regulations regarding such a use. Nothing herein shall be deemed to prevent the Owner from leasing his Lot for a term of not less than six (6) consecutive months, subject to the provisions of the Association Articles, Bylaws and rules and regulations and this Declaration, as they may be amended from time to time provided, however, that all prospective tenants must first be approved by the Board of Directors or such review committee as the Board may designate. The Board of Directors may evict tenants upon reasonable notice for a major violation, or repeated minor violations, of the provisions of the Association Articles, Bylaws and rules and regulations or this Declaration.

COPY

COPY

COPY

(f) No nuisance shall be permitted to exist or operate on any Lot or Common Area so as to be detrimental to any other Lot in the vicinity thereof, or to its occupants, or to the Common Areas.

(g) No Owner shall be entitled to use water from any of the lakes or other water retention areas comprising a part of the Stormwater Retention System for irrigation purposes without the Developer's prior written consent, which consent may be withheld in the Developer's sole and absolute discretion.

(h) No immoral, improper, offensive or unlawful use shall be made of the Property or any part thereof. All laws, zoning ordinances, orders, rules, regulations or requirements of any governmental agency having jurisdiction thereof, relating to any portion of the Property, shall be complied with, by and at the sole expense of the Owner or the Association, whichever shall have the obligation to maintain and repair such portion of the Property. No waste will be committed in the Common Areas.

(i) Nothing shall be done or kept on any Lot or in the Common Areas which will increase the rate of insurance for the Property or any other Lot, or the contents thereof, without the prior written consent of the Association. No Owner shall permit anything to be done or kept on his Lot or in the Common Areas which will result in the cancellation of insurance on the Property or any other Lot, or the contents thereof, or which will be in violation of the law.

(j) Owners shall allow the Board of Directors or the agents and employees of the Association to enter any Lot for the purpose of maintenance, inspection, repair, replacement of the improvements within the Yards or, in the case of emergency, for any purpose, or to determine compliance with this Declaration.

JAX\1165338\_2 -25- COPY

(k) Pets of the customary household variety, such as cats, dogs, pet birds and fish may be kept by an Owner on his Lot, but only if such pets do not cause a disturbance or annoyance on the Property. All pets must be held or kept leashed at all times if they are in the Common Areas, and pet owners shall immediately collect and properly dispose of the waste and litter of their pets. The Association reserves the right to limit those parts of the Common Areas where pets may be walked and to make reasonable rules and regulations restricting the number and type of pets that may be kept on any Lot. The Association reserves the right to demand that an Owner remove such pet from the Property if such pet is found to be a nuisance or is in violation of this Declaration.

(l) Except as may be required by legal proceedings, no sign, advertisement or notice of any type or nature whatsoever may be erected or displayed upon any Lot, House, Common Area or Yard or from any window, unless express prior written approval of the size, shape, content and location has been obtained from the Board of Directors which approval may be withheld in its discretion. Notwithstanding the foregoing, the Developer shall be permitted to post and display advertising signs on the Property and the Association Board of Directors may erect reasonable and appropriate signs on any portion of the Common Areas.

(m) Go carts and mini-bikes shall not be allowed anywhere within the Property.

(n) No obstruction of visibility of street intersections shall be permitted. The ARB shall have the right to adopt additional restrictions concerning the height and type of trees and shrubs within any of the Lots.

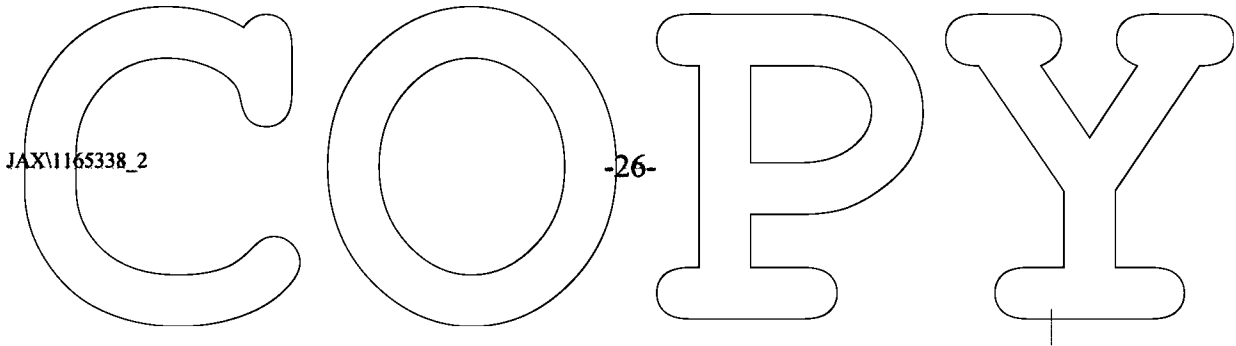

(o) No clothesline, or other clothes drying facility, shall be permitted in the Common Areas, Yards or any area of the Property wherein the same may be visible from any Common Road or any other Lot.

(p) All garbage and trash containers must be placed and maintained in accordance with Association rules and regulations. No garbage or trash shall be placed anywhere except as aforesaid and no portion of the Property shall be used for dumping refuse.

(q) Subject to the Federal Communications Commission rule 47 C.F.R. Section 1.4000, as may be amended from time to time, no exterior radio or television antenna, satellite dish or other receiver or transmitting device or any similar exterior structure or apparatus may be erected or maintained on any Lot unless adequately screened from view as determined by the ARB.

(r) Air conditioning units shall be shielded and hidden so that they are not readily visible from the Common Areas or adjacent Lots. No window air conditioning units shall be installed in any House.

(s) No structure of a temporary character, trailer, tent, shack, barn, shed or other outbuilding shall be permitted on any Lot at any time, other than:

(i) Cabanas appurtenant to a swimming pool, detached garages and gazebos as approved by the ARB;

(ii) Temporary structures installed by Developer during the initial construction period; and

(iii) Tents or other temporary structures for use during social functions.

(t) No septic tanks or individual wells shall be permitted on any Lot within the Property other than wells for heat transfer systems of heating and air conditioning units, to

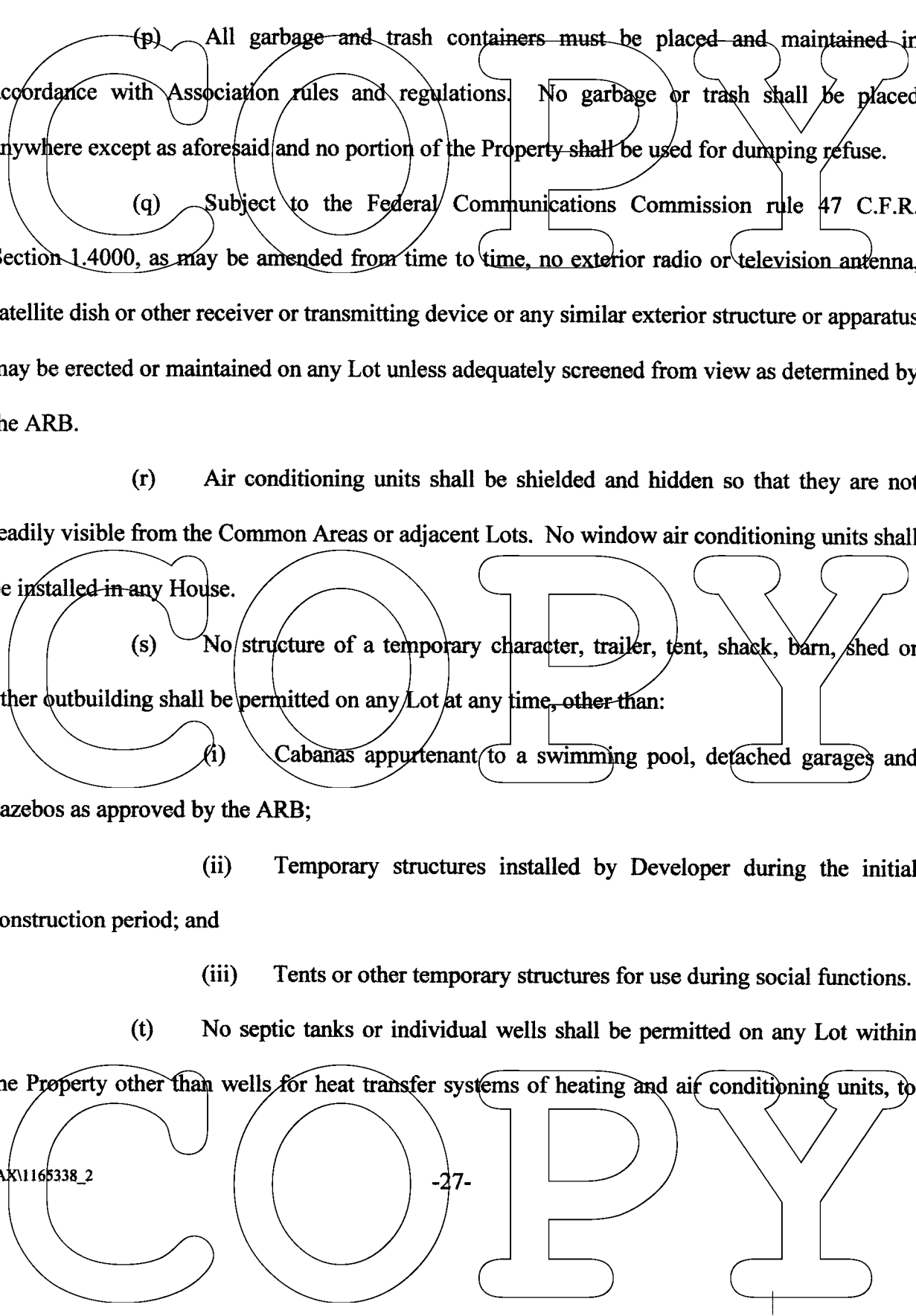

the extent such wells are permitted by law and the ARB. No Owner shall obstruct or make any modification or alteration of any irrigation system without the prior approval of the ARB.

(u) No visible fuel or gas storage tanks may be affixed on any Lot. Notwithstanding this, an Owner may keep and maintain a small gas tank for gas barbecues and fireplaces in an area of his Lot as specifically approved by the ARB.

(v) Garage doors shall be kept closed except when automobiles are entering or leaving the garage. All vehicles shall be kept inside garages or on the driveway and shall not be kept on the street. Notwithstanding the restriction set forth in this Article VII, Section 1(v), in the event an Owner is having a function, party or gathering (collectively, an "Event") where Owner anticipates that vehicles will need to be temporarily parked on the street during the Event, Owner shall provide written notice to the Association prior to the Event.

(w) No soliciting will be allowed at any time within the Property.

(x) The portions of the House visible from other Lots and the Common Areas, and all yards and entrances, must be kept in an orderly condition so as not to detract from the neat appearance of the Property. The Board of Directors, in its sole discretion, may determine whether or not the visible portions of the Houses and Yards are orderly. The Association may have any objectionable items removed from any Yard so as to restore its orderly appearance, without liability therefor, and charge the Owner for any costs incurred in the process, all as more particularly set forth in Article V, Section 5 hereof.

(y) All mailboxes and name signs for such mailboxes must be approved by the ARB.

(z) No watercraft may be used on any body of water on the Property without the prior approval of the Association Board of Directors.

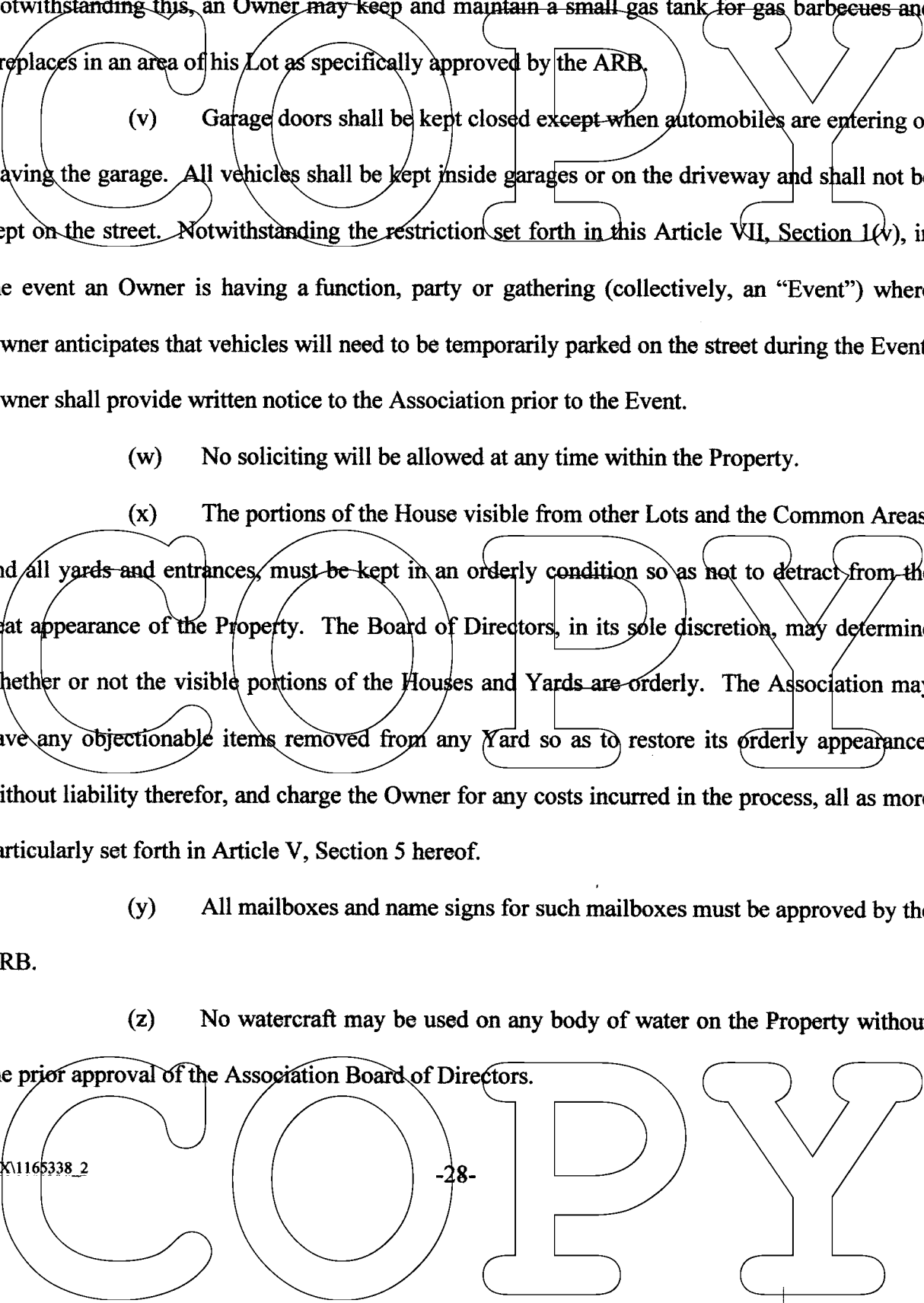

(aa) No fences shall be erected without approval by the ARB. The ARB shall have the right to approve the material used and the location of all such fences, however, no chainlink fences or other metal fences of any kind shall be permitted.

(bb) Subject to the terms of this section, there shall be no outside storage or parking upon any Lot or within any portion of the Common Areas (other than areas provided therefor within the Common Areas, if any) of any mobile home, trailer (either with or without wheels), motor home, tractor, truck, (other than pickup trucks), or commercial vehicles of any type, camper, motorized camper or trailer, boat or other watercraft, boat trailers, motorcycle, motorized bicycle, motorized go-cart or any other related forms of transportation devices. No Owners or other occupants of any portion of the Property shall repair or restore any vehicle of any kind upon or within any Lot or within any portion of the Common Areas, except (i) within enclosed garages or workshops or (ii) for emergency repairs, and then only to the extent necessary to enable the movement thereof to a proper repair facility.

(cc) Notwithstanding any provisions or restrictions contained in this Declaration to the contrary, it shall be expressly permissible for Developer and its agents, employees, successors and assigns to maintain and to carry on such facilities and activities as may be reasonably required, convenient or incidental to the completion, improvement and sale, or the developing of, the Lots and Common Areas, including, without limitation, the installation and operation of sales and construction trailers and offices, signs and model dwellings, provided the location of any construction trailers of any assignees of Developer's rights under this section shall be subject to Developer's approval. The right to maintain and carry on such facilities and activities shall include specifically the right to use Houses as model residences or as offices for

COPY

COPY

COPY

the sale of Lots and for related activities. Developer's right of use, as described hereinabove, shall continue even after conveyance of any or all of the Common Areas to the Association.

(dd) No construction activity, other than work to be performed on the inside of a House which is closed in, nor delivery of construction materials, shall be permitted between the hours of 7:00 p.m. and 7:00 a.m. of the following day.

(ee) No discharge of any hazardous or toxic substances including, without limitation, fuel and petrochemicals, paint or primer shall be permitted on the Property.

**Section 2.** The Board of Directors may, from time to time, adopt rules or amend previously adopted rules and regulations governing the details of the operation, use, maintenance and control of the Lots and Common Areas, and any facilities or services made available to the Owners.

**Section 3.**

(a) It shall be the responsibility of each Owner to conform and abide by the rules and regulations in regard to the use of the Lots and Common Areas which may be adopted in writing from time to time by the Board of Directors, or the ARB, and to see that his family members, Guests, tenants, employees, agents and contractors do likewise.

(b) Upon violation of any of the rules or regulations adopted as herein provided, or upon violation of any of the provisions of this Declaration by an Owner, or his family members, tenants or Guests, the Association may levy fines against the Owner and his Lot as determined by the Board of Directors and/or suspend the voting rights of the Member. To enforce the rules and regulations or provisions of this Declaration, the Association, or any Owner may bring an action for specific performance, declaratory decree, injunction or damages. The prevailing party shall recover costs and attorneys' fees in such suit.

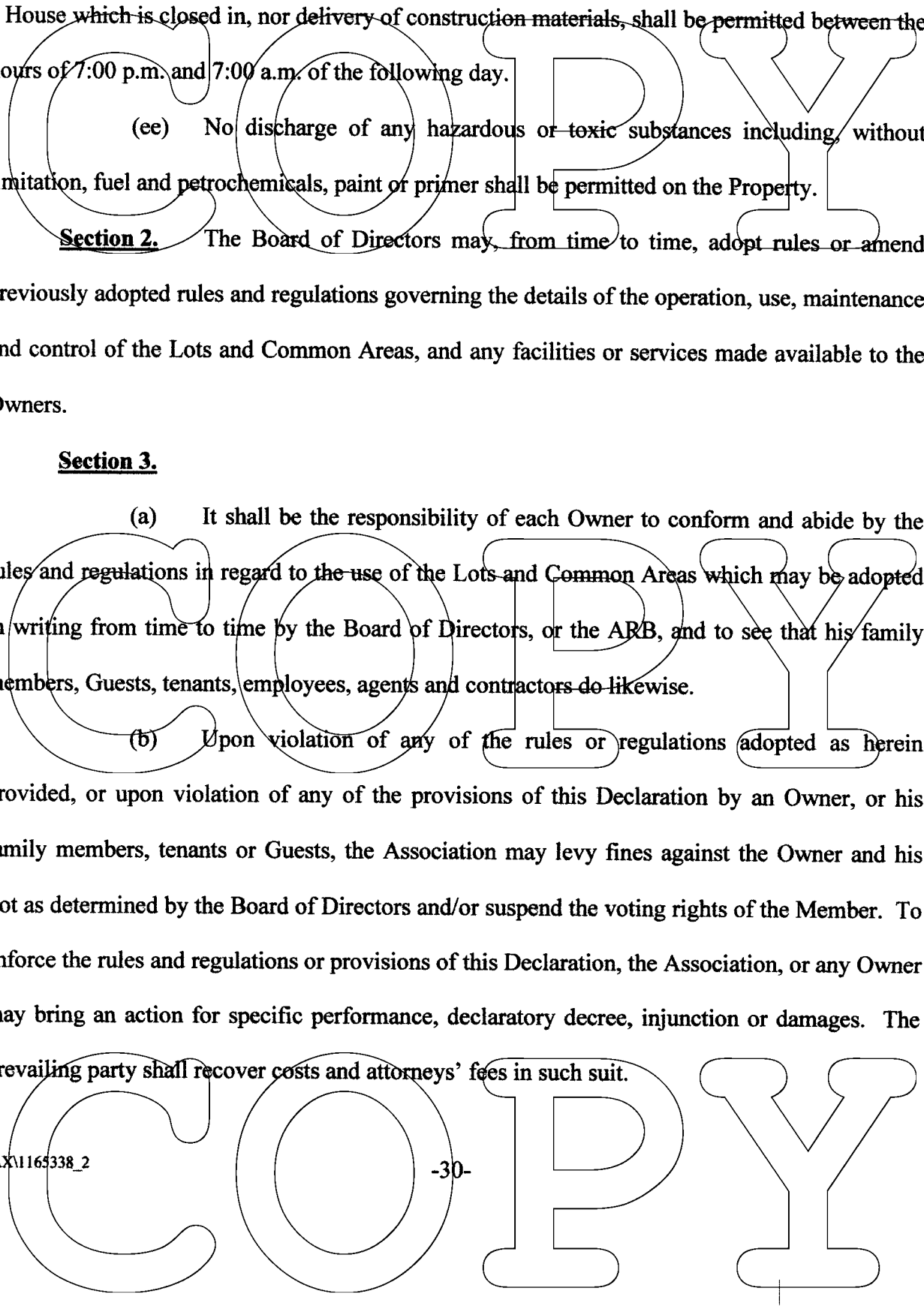

**Section 4.** Employees, agents and workers of the Association shall not be required to attend to any personal matters or business of Owners, nor shall they be permitted to leave the Property on any private business of Owners. The uses and functions of the employees shall be governed by the Board of Directors. In the event personal services are provided to Owners by any of the employees, agents or workers of the Association, the said Association assumes no responsibility or liability in any manner for the quality of such services or work. In addition, the Association shall not be liable for any injury to persons or damage to property resulting from any act or omission by those performing such personal work or services for any Owner.

**ARTICLE VIII**

**UTILITY EASEMENTS AND OTHER EASEMENTS**

**Section 1.**

(a) Developer reserves for itself and for the Association and its designees a ten foot (10') easement for the benefit of the Property upon, across, over, through and under, along and parallel to each front and rear Lot line for ingress, egress, installation, replacement, repair and maintenance of utility lines and facilities, for drainage, for police powers and for services supplied by either Developer or the Association. By virtue of this easement it shall be expressly permissible for Developer or the Association to install and maintain facilities and equipment on the Property, to excavate for such purposes and to affix and maintain wires, circuits, pipes and conduits on and under the Lots. This easement shall be in addition to, rather than in place of, any other recorded easements on the Property.

(b) Developer hereby reserves for itself and for the Association and its designees a five foot (5') easement for the benefit of the Property upon, across, over, through and under, along and parallel to each side Lot line for access, ingress, egress and for drainage. By

virtue of this easement, it shall be expressly permissible for Developer and the Association to install and maintain drainage facilities and equipment on the Property, to excavate for such purposes and to affix and maintain pipes under the Lots. This easement shall be in addition to, rather than in place of, any other recorded easements on the Property.

**Section 2.**

(a) The Developer creates and reserves for the benefit of itself and all present and subsequent owners, a perpetual nonexclusive easement over, upon and across the Stormwater Retention System for the purpose of drainage of the Property in compliance with the terms and conditions of permit(s) issued by the St. Johns River Water Management District or its successor agency and for maintenance of the Stormwater Retention System.

(b) The Developer hereby reserves unto itself, and its assignees, a perpetual, alienable easement over the lakes and other water retention areas comprising a part of the Stormwater Retention System for the use of the water therein for irrigation purposes. The use of such water shall be subject to the draw down restrictions established by the St. Johns River Water Management District and all other governmental regulations.

(c) Developer creates and reserves for itself and for the Association and its designees a blanket easement and right on, over and under the ground within the Property to maintain and correct drainage of surface water and other erosion controls in order to maintain reasonable standards of health, safety and appearance. Said right expressly includes the right to cut any trees, bushes or shrubbery, make any gradings of the soil, take up pavement or to take any other similar action reasonably necessary, following which Developer or the Association, as applicable, shall restore the affected property to its original condition as nearly as practicable. Developer or the Association shall give reasonable notice of intent to take such action to all

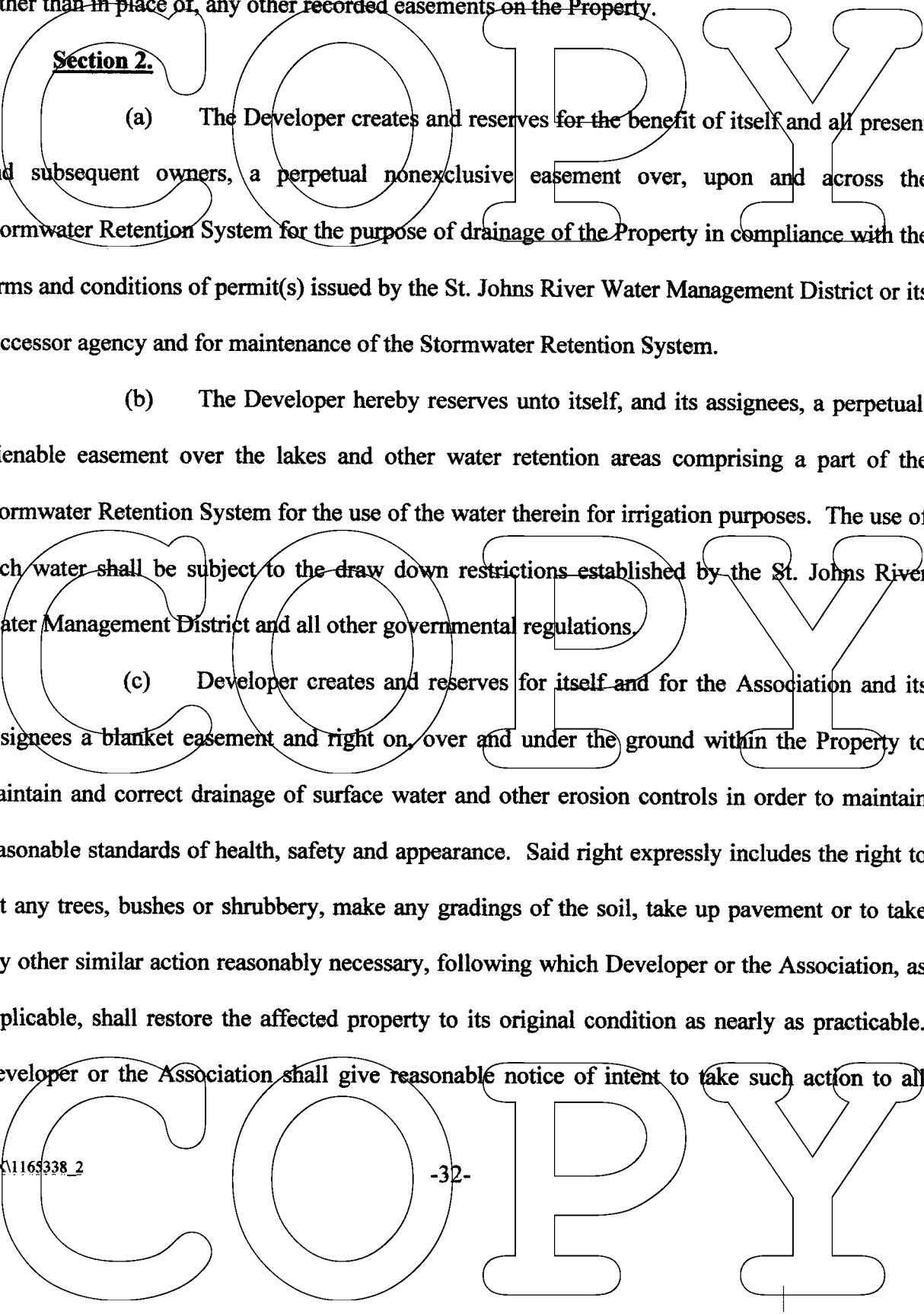

affected Owners, unless in the opinion of the Developer, or the Association an emergency exists which precludes such notice. The right granted hereunder may be exercised at the sole option of Developer or the Association, and shall not be construed to obligate Developer or the Association to take any affirmative action in connection therewith.

**Section 3.** Developer hereby reserves for itself, the Association and the Owners an easement over and under all lakes within the Property for drainage of surface water.

**Section 4.** To the extent that any improvements constructed by Developer on or if any Lot encroaches on any other Lot or Common Area, whether by reason of any deviation from the subdivision plat(s) of the Property or by reason of the settling or shifting of any land or improvements, a valid easement for such encroachment and the maintenance thereof shall exist. Upon the termination of such an encroachment, the easement created in this Section 4 shall also terminate.

**Section 5.** There is hereby reserved to the Association the right, which shall also be its duty and responsibility, to maintain the Common Area in accordance with the Declaration and the Association Articles of Incorporation, Bylaws and rules and regulations.

**ARTICLE IX**

**GENERAL PROVISIONS**

**Section 1.** The covenants and restrictions contained in this Declaration, as the same may be amended from time to time, shall run with and bind the Property and shall inure to the benefit of and be enforceable by the Declarant, the Association, the Owners and their respective legal representatives, heirs, successors or assigns, for a term of thirty (30) years after the date that this Declaration is recorded in the Public Records of St. Johns County, Florida, after which time all of said provisions shall be extended automatically for successive periods of ten (10)

years each unless an instrument signed by the President and Secretary of the Association certifying that the Owners holding 75% of the total voting power in the Association have agreed to terminate all of the said provisions as of a specified date shall have been recorded. Unless this Declaration is terminated in accordance with this section, the Association shall rerecord this Declaration or other notice of its terms at intervals necessary under Florida law to preserve its effect.

**Section 2.** In the event all or part of the Common Area owned by the Association shall be taken or condemned by any authority having the power of eminent domain, all compensation and damages shall be paid to the Association. The Board of Directors of the Association shall have the sole and exclusive right to act on behalf of the Association with respect to the negotiation and litigation of the taking or condemnation affecting such property.

**Section 3.** Any notice required to be sent to the Owner of any Lot under the provisions of this Declaration shall be deemed to have been properly sent when mailed, first-class postage prepaid, or hand delivered to the last known address of the person who appears as Owner of such Lot on the records of the Association at the time of such mailing.

**Section 4.** In addition to the enforcement provisions previously set forth in this Declaration, the provisions of this Declaration may be enforced by any Owner, the Association, or Developer (as long as it holds any interest in the Property) by a proceeding at law or in equity against any person or entity violating or attempting to violate the same, either to restrain violation or to recover damages, or both, and against his or its property to enforce any lien created by this Declaration. Failure to so enforce any of these protective covenants and restrictions shall in no event be deemed a waiver of the right to do so at any time thereafter.

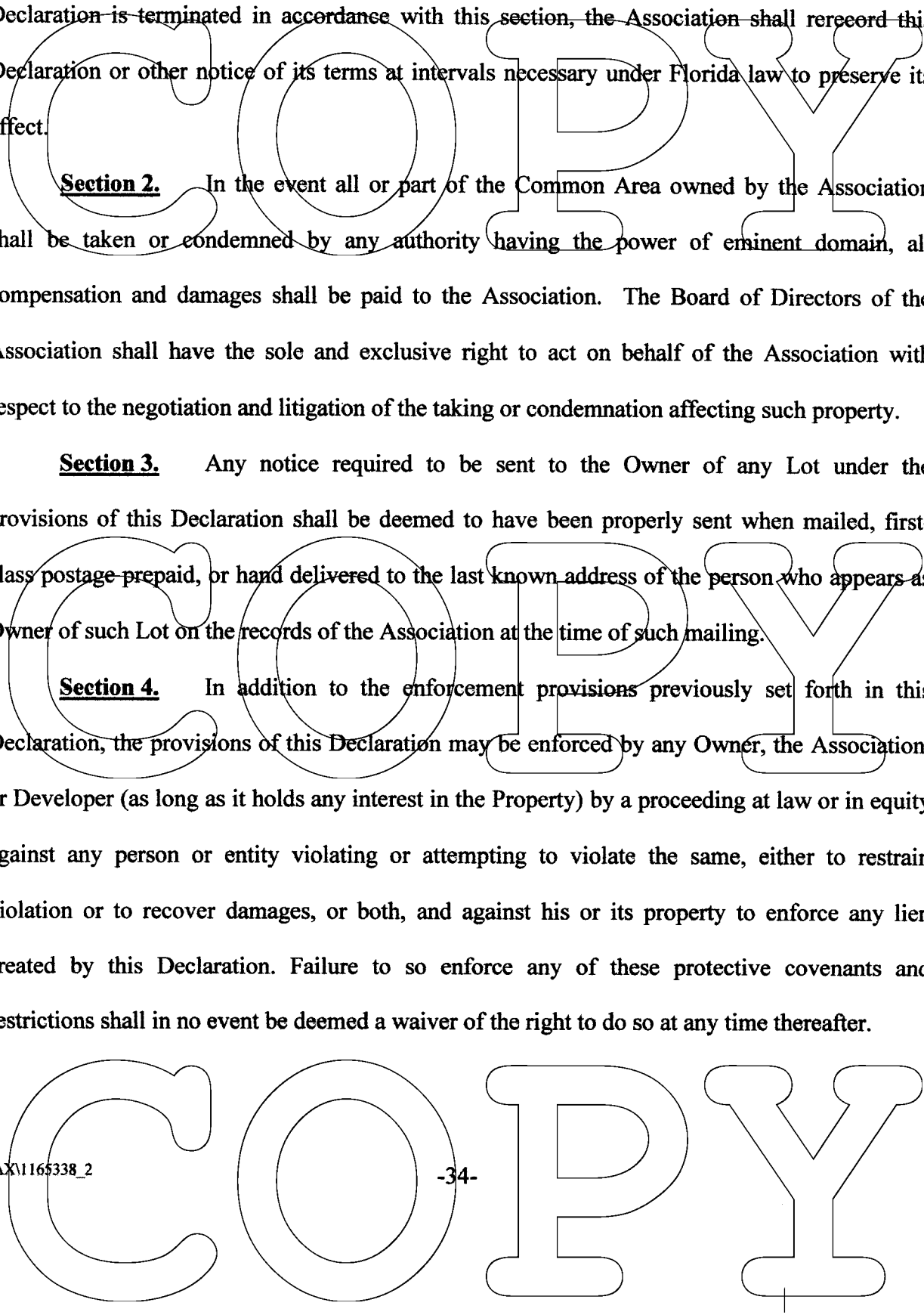

**Section 5.** The provisions of this Declaration shall be liberally construed to effectuate their purpose of creating a uniform consistent plan for the development and use of the Property.

**Section 6.** The invalidity of any part of this Declaration shall not impair or affect in any manner the validity and enforceability of the balance of the Declaration which shall remain in full force and effect.

**Section 7.** The use of the masculine gender herein shall be deemed to include the feminine gender and the use of the singular shall be deemed to include the plural, whenever the context so requires.

**Section 8.**

(a) On or before Turnover, the Developer reserves and shall have the right, without the consent or joinder by the Owners:

(i) to amend this Declaration for the purpose of curing any ambiguity in or any inconsistency between the provisions contained herein;

(ii) to release any Lot from any part of the covenants and restrictions contained herein which have been violated if the Developer, in its sole judgment, determines such violation to be a minor or insubstantial violation;

(iii) to amend this Declaration to annex all of any portion of the Additional Property hereto and to amend these covenants and restrictions as to such additional property to add to or alter these restrictions to reflect the unique and different character of each such property. Developer's right to so annex all or any portion of the Additional Property to this Declaration shall expire fifteen (15) years from the date hereof. The annexation of any portion of the Additional Property shall be evidenced by an amendment to this Declaration recorded in

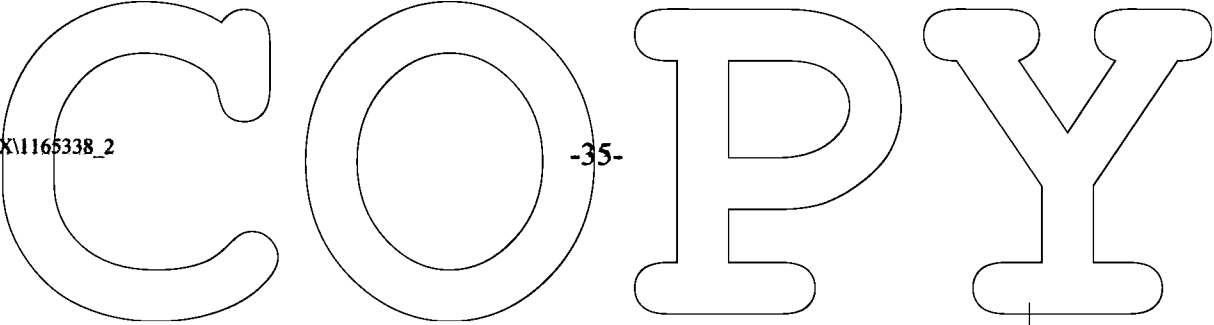
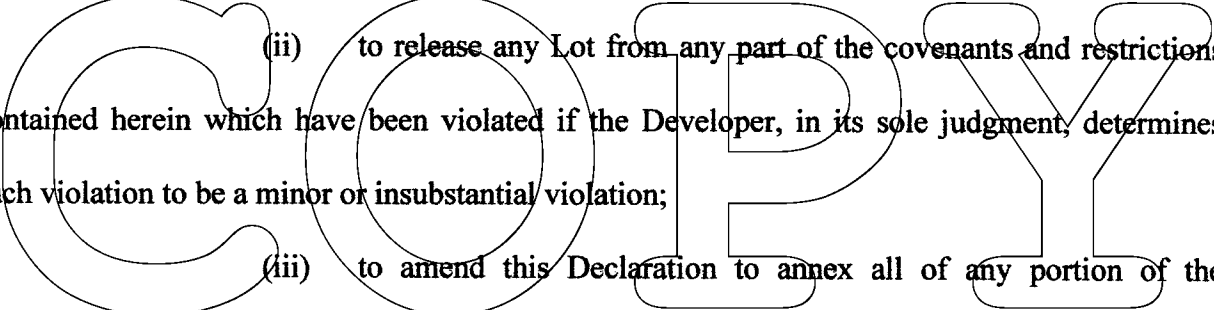
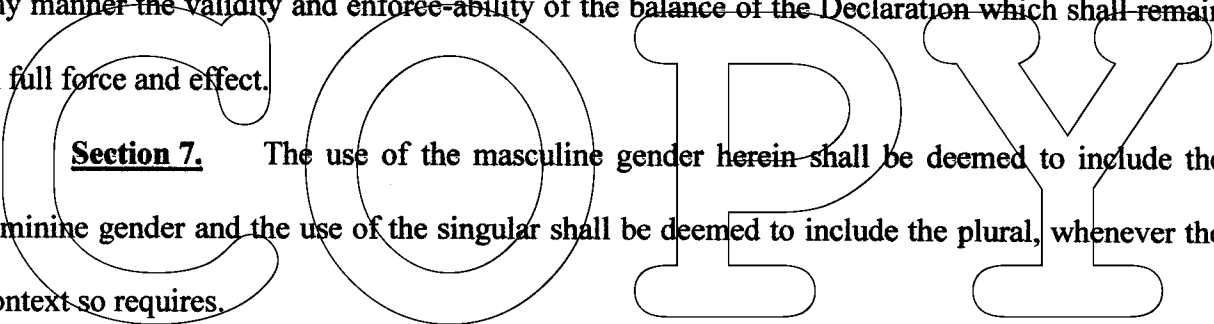

the public records of St. Johns County, Florida describing the property to be annexed and stating that such property is subject to this Declaration.

(b) Subject to the provisions of Article IX, Section 10, Developer specifically reserves the absolute and unconditional right, up until Turnover, to amend this Declaration without the consent or joinder of any party to (i) conform to the requirements of the Federal Home Loan Mortgage Corporation, Federal National Mortgage Association or any other generally recognized institution involved in the purchase and sale of home loan mortgages or (ii) to conform to the requirements of institutional mortgage lender(s) or title insurance company(s) or (iii) to perfect, clarify or make internally consistent the provisions herein or (iv) to subject any additional property owned by the Declarant or an Affiliate to this Declaration.

(c) Subject to the provisions of Article IX, Section 10, Developer reserves the right to amend this Declaration in any other manner without the joinder of any party until Turnover so long as (i) the voting power of existing Members is not diluted thereby, (ii) the assessments of existing Owners are not increased except as may be expressly provided for herein, and (iii) no Owner's right to the use and enjoyment of his Lot or the Common Areas is materially altered thereby.

(d) This Declaration may be amended at a duly called meeting of the Association whereat a quorum is present if the amendment resolution is adopted by (i) a majority of all Class A Members of the Association and (ii) the Developer, so long as the Developer is a Class B Member. An amendment so adopted shall be effective upon the recordation in the public records of St. Johns County of a copy of the amendment resolution, signed by the President of the Association and certified by the Secretary of the Association.

COPY

**Section 9.**

(a) This Declaration contains provisions concerning various rights, priorities, remedies and interests of the Mortgagees. Such provisions are to be construed as covenants for the protection of the Mortgagees on which they may rely in making loans secured by mortgages on the Lots. Accordingly, no amendment or modification of this Declaration impairing such rights, priorities, remedies or interests of a Mortgagee shall be adopted without the prior written consent of all Mortgagees holding liens on eighty percent (80%) or more of the Lots encumbered by Mortgages. Any such consent requested by Developer of Mortgagees shall be given prompt consideration and shall not be unreasonably withheld. This section shall not apply or be construed as a limitation upon those rights of Developer, the Association or the Owners under this Declaration to make amendments which do not adversely affect the Mortgagees.

(b) The provisions of Article IV, Section 1 requiring the Association to maintain and administer the Stormwater Retention System in accordance with all permits and rules and regulations issued by the St. Johns River Water Management District were required by the St. Johns River Water Management District as a condition to the issuance of the permit described in Article I(x) hereof. Accordingly, no amendment or modification of this Declaration regarding the Association's duty or obligation to maintain and administer the Stormwater Retention System shall be adopted without the prior written consent of the St. Johns River Water Management District. This subsection shall not apply or be construed as a limitation upon those rights of Developer, the Association or the Owners under this Declaration to make amendments which do not adversely affect the St. Johns River Water Management District.

**Section 10.** Any and all legal fees, including but not limited to attorneys' fees and court costs, including any appeals, which may be incurred by the Association in the lawful

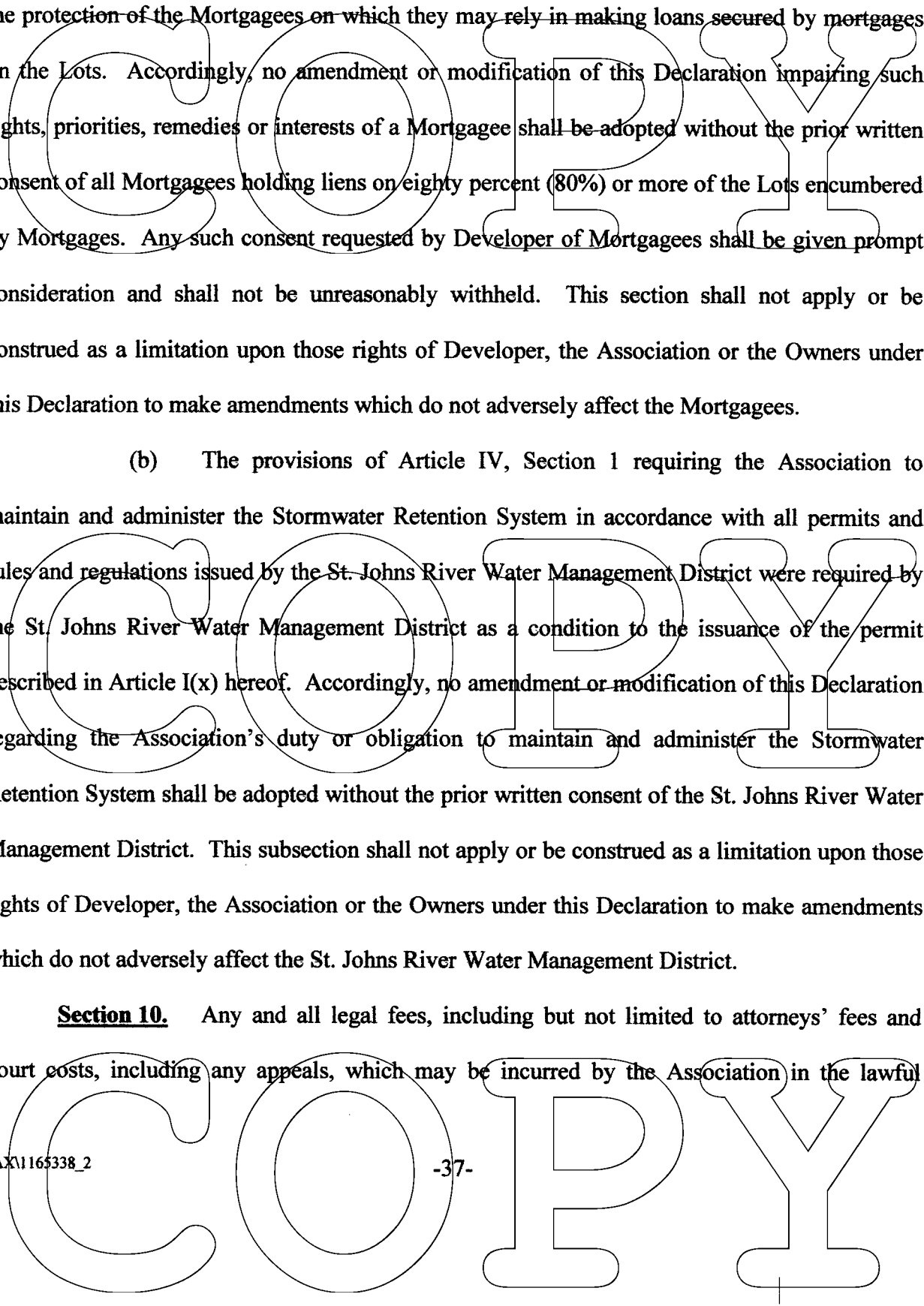

enforcement of any of the provisions of this Declaration, regardless of whether such enforcement requires judicial action, shall be assessed against and collectible from the unsuccessful party to the action, and if an Owner, shall be a lien against such Owner's Lot in favor of the Association.

**Section 11.** This Declaration shall be construed in accordance with the laws of the State of Florida.

**Section 12.** All rights and privileges herein conferred by the Developer shall be exercisable by such successor in title as is designated by Developer. In addition, all rights and privileges herein contained shall be assignable by Developer.

IN WITNESS WHEREOF, the undersigned, being the Developer herein, does hereby make this Declaration of Easements, Covenants, Conditions, Restrictions and Easements for and has caused this Declaration to be executed in its name on the day and year first above written.

Signed, sealed and delivered in the presence of:

**"DEVELOPER"**

**COUNTRYWALK, LLC,**  
a Florida limited liability company,

**BY: TWT Development Corporation,**  
a Florida corporation, its Managing Member

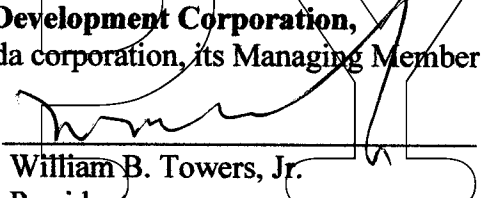
By:   
Name: William B. Towers, Jr.  
Title: President

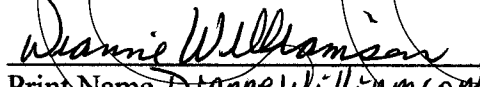
  
Print Name Dianne Williamson

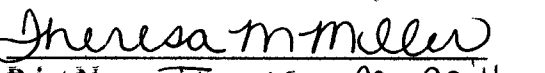
  
Print Name Theresa M. Miller

COPY

STATE OF FLORIDA  
COUNTY OF Duval

The foregoing instrument was acknowledged before me this 27<sup>th</sup> day of November, 2007, by William B. Towers, Jr., as President of **TWT Development Corporation**, a Florida corporation, the Managing Member of **COUNTRYWALK, LLC**, a Florida limited liability company, on behalf of the corporation and the company (*select one*)  who is personally known to me or  who has produced a Florida driver's license as identification.

**COPY**  
Name: Dianne Williamson  
Notary Public, State of Florida  
My Commission Expires \_\_\_\_\_  
My Commission Number is: \_\_\_\_\_

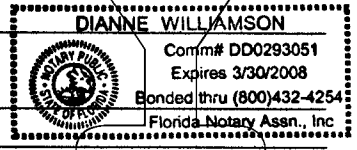

**COPY**

**COPY**

**EXHIBIT "A"**

**Legal Description**

**COUNTRY WALK** Being a portion of the Southeast ¼, and the Southwest ¼ of Section 17, Township 8 South, Range 29 East, St. Johns County, Florida.

A portion of Section 17, Township 8 South, Range 29 East, St. Johns County, Florida, being more particularly described as follows: BEGINNING at a four (4) inch square concrete monument at the Southeast corner of said Section 17; thence South 89°44'14" West, along the South line of said Section 17, a distance of 1203.77 feet; thence North 65°45'04" West, departing said South line, 2085.25 feet; thence North 00°43'51" West, 1768.03 feet to a point situate on the North line of the Southwest ¼ of said Section 17; thence North 89°59'56" East, along said North line and along the North line of the Southeast ¼ of said Section 17, and along the South line of boundary of Vermont Heights Unit No. 2, as recorded in Map Book 3, Page 110 of the Public Records of said St. Johns County, and along the South line of Vermont Heights Unit No. 1, as recorded in Map Book 3, Pages 77 of said Public Records and along the South line of Vermont Heights (combining Vermont Heights Units 1 and 2) as recorded in Map Book 5, Page 29 of said Public Records, 1780.55 feet to a point situate in the Southwesterly line of Block 64, said plat of Vermont Heights Unit No. 1; thence South 27°16'25" East, along the Southeasterly prolongation of said Southwesterly line of Block 64 and along the Southwesterly line of those certain lands described in Official Records Book 1076, Page 1818 of said Public Records, 89.90 feet; thence North 62°36'13" East, along the Southwesterly prolongation of the Southeasterly line of said Block 64 and along the Southeasterly line of said last mentioned lands, 173.66 feet to said Northerly line of the Southeast ¼; thence North 89°59'56" East, along said last mentioned line, 29.64 feet; thence South 27°16'25" East, along the Southwesterly line of those certain lands described in Official Records Volume 1834, Page 1061 of said Public Records, 126.36 feet; thence North 62°36'13" East, along the Southeasterly line of said last mentioned lands, 150.89 feet; thence North 89°17'50" East, 54.68 feet; thence South 26°30'23" East, 74.54 feet; thence North 62°16'04" East, 201.21 feet to a point situate in the Southwesterly right of way line of New Hampshire Avenue as shown on said plat of Vermont Heights, Unit No. 1; thence South 27°16'25" East, along said Southwesterly right of way line, and along the Southwesterly boundary of Block 79, Vermont Heights, as recorded in Map Book 4, Page 45 of said Public Records, 282.08 feet; thence North 62°36'13" East, along the Southeasterly right of way line of Fifteenth Street as shown on said last mentioned plat, 567.30 feet to a point situate in the East line of said Southeast ¼, said point being situate South 00°41'00" East, 4.99 feet from a four (4) inch by four (4) inch concrete monument (RLS 2020) at the Northeast corner of said Southeast ¼; thence South 00°41'00" East, along said East line of the Southeast ¼, the same being the East line of said Section 17, a distance of 2614.03 feet to the POINT OF BEGINNING.

JAX1165338\_2

-40-

COPY

**EXHIBIT "B"**

**Association Articles of Incorporation**

COPY

COPY

COPY

JAX\1163338\_2

Nov. 2. 2006 4:56PM

No. 0319 P. 2  
HUG000267385

FILED

06 NOV -3 PM 12: 27

SECRETARY OF STATE  
TALLAHASSEE, FLORIDA

**ARTICLES OF INCORPORATION  
OF  
COUNTRYWALK OWNERS ASSOCIATION, INC.**

**COPY**

The undersigned incorporator hereby forms a corporation not for profit (the "Corporation") under the laws of the State of Florida, pursuant to Chapter 617 and Chapter 720, Florida Statutes (the "Act"), and to that end hereby sets forth:

**ARTICLE I**

**NAME OF CORPORATION**

The name of the corporation **COUNTRYWALK OWNERS ASSOCIATION, INC.** (hereinafter called the "Association").

**ARTICLE II**

**DEFINITIONS**

Unless otherwise provided in these Articles of Incorporation, all terms used in these Articles of Incorporation shall have the same definitions and meanings as those set forth in the Declaration of Covenants, Conditions and Restrictions for CountryWalk recorded or to be recorded in the Public Records of St. Johns County, Florida, as it may be amended and/or supplemented from time to time (hereinafter called the "Declaration").

**COPY**

**ARTICLE III**

**PRINCIPAL OFFICE OF THE ASSOCIATION**

The principal place of business and the mailing address of the Association is located at **6215 Wilson Boulevard, Jacksonville, Florida 32210.**

**ARTICLE IV**

**REGISTERED OFFICE AND REGISTERED AGENT**

The initial registered office of the Association shall be located at **6215 Wilson Boulevard, Jacksonville, Florida 32210**, and the initial registered agent of the Association shall be **Linda J. Richardson**. The Association may change its registered agent or the location of its registered office, or both, from time to time, without having to amend these Articles of Incorporation.

**COPY**

HUG000267385

Nov. 2. 2006 4:56PM

No. 0319 P. 3  
F100000207385

**ARTICLE V**  
**PURPOSE AND POWERS OF THE ASSOCIATION**

**Section I. Purpose.** The objects and purposes of the Association are those objects and purposes as are authorized by the Declaration of Covenants, Conditions and Restrictions of CountryWalk recorded (or to be recorded) in the Public Records, as hereafter amended and/or supplemented from time to time (the "Declaration"). The further objects and purposes of the Association are to:

(a) Preserve the values in the Property and to maintain the Common Property thereof for the benefit of the Owners who become members of the Association.

(b) To carry on one or more exempt functions of a homeowners association under the Internal Revenue Code of 1986, as amended (the "Code"), including those activities related to the acquisition, construction, management, maintenance, and care of association property (as defined in Section 528(e)(4) of the Code), all pursuant to such rules and policies as shall be set forth in its Bylaws;

(c) To make and collect Assessments and other charges against members as Owners (whether or not such sums are due and payable to the Association), and to use the proceeds thereof in the exercise of its powers and duties including without limitation to the maintenance and operation of the Water Management System, including but not limited to work within the retention areas, drainage structures or drainage easements;

(d) To operate, maintain and manage the Surface Management System in a manner consistent with the Water Management District requirements and applicable District rules, and shall assist in the enforcement of the restrictions and covenants contained in the Declaration. The Association shall not pay a dividend to its members and shall make no distribution of income to its members, director or officers, and upon dissolution, all assets of the Association shall be transferred only to another non-profit corporation or a public agency or as otherwise authorized by the Florida Not For Profit Corporation Act (Chapters 617 and 720, Florida Statutes) and as may be approved by the Water Management District, with respect to the transfer of the Water Management System; and

(e) To do such other acts and things, and engage in any lawful act or activity, for which corporations may be organized under, and as are authorized and permitted by, the Act and to have and exercise all powers necessary or convenient to effect any or all of the purposes for which the Corporation is organized; provided, however, that in all events and circumstances, no part of any net earnings of the Corporation shall inure (other than by acquiring, constructing, or providing management, maintenance, and care of association property, and other than by a rebate of excess membership dues, fees, or assessments) to the benefit of any member of the Corporation or to the benefit of any private shareholder or individual (as defined in accordance with Treasury Regulations Section 1.528-7 promulgated under the Code), the Corporation being

JAN060301\_1

**COOPY**

F106000267385

Nov. 2. 2006 4:57PM

No. 0319 P. 4  
H06000267385

organized to provide, among other things, for the acquisition, construction, management, maintenance, and care of association property.

**Section 2. Powers.** The Association shall have the following powers:

(a) All of the common law and statutory powers of a not-for-profit corporation organized under the laws of the State of Florida, subject only to such limitations upon the exercise of such powers as are expressly set forth in these Articles of Incorporation, the Bylaws or the Declaration.

(b) To enter into, make, establish, amend and enforce, rules, regulations, Bylaws, covenants, restrictions and agreements to carry out the purposes of the Association. The Association may use any enforcement method authorized by the Declaration and/or Florida law, including but not limited to, fines, suspensions of use rights to Common Property, actions for damages, equitable actions, injunctive relief, administrative actions, or any combination of those.

(c) To fix, levy and collect Assessments for Common Expenses from Owners to defray the costs, expenses, reserves and losses incurred or to be incurred by the Association and to use the proceeds thereof in the exercise of the Association's powers and duties, including, but not limited to, the maintenance, operation, repair and/or replacement of the Master Surface Water Management System.

(d) To fix, levy and collect Special Assessments for Common Expenses from Owners to defray the costs, expenses, reserves, losses, damages and budget shortfalls incurred or to be incurred by the Association and to use the proceeds thereof in the exercise of the Association's powers and duties.

(e) To make, adopt, establish, amend and enforce rules and regulations regarding the use, appearance and/or condition of any portion of the property bound by the terms, covenants, conditions and restrictions of the Declaration, including but not limited to, Common Property, Lots, Members, structures, improvements, landscaping and maintenance.

(f) To own, purchase, sell, mortgage, lease, administer, manage, operate, maintain, improve, repair and/or replace real property and personal property.

(g) To borrow and to hold funds, select depositories, administer bank accounts of the Association, and to pay all expenses, including licenses, public assessments, taxes or government charges, incident to the purposes and powers of the Association, as set forth in these Articles of Incorporation and as may be provided in the Declaration and the Bylaws.

(h) To purchase insurance for the protection of the Association, its Officers, Directors, Members and such other parties as the Association may determine to be in the best interests of the Association. To require Members to purchase insurance for the protection of their Lots and any structures, landscaping and/or improvements thereon.

JAN140201\_3

COPY

H06000267385

Nov. 2. 2006 4:57PM

No. 0319 P. 5  
H06000267385

(f) To operate, maintain, manage, repair, control, regulate, replace and/or improve all Common Property and such other portions of the Property as may be determined by the Association from time to time.

(g) To enter into contracts and agreements between third parties and the Association.

(h) To exercise architectural control, either directly or through appointed committees, over all buildings, structures, landscaping and/or improvements of any type to be placed, built and/or constructed upon any portion of the Property. Such architectural control shall be exercised pursuant to the Declaration.

(i) To provide for any functions and services within the Property as the Board of Directors in its sole discretion determines necessary or appropriate.

(j) To provide, purchase, sell, lease, acquire, replace, improve, maintain and/or repair such buildings, structures, pathways, landscaping, paving, equipment and property, both real and personal, as the Association, through its Board of Directors, in its discretion determines necessary or appropriate.

(k) To employ any personnel necessary to perform the obligations, services and/or duties required of or to be performed by the Association and/or to contract with others for the performance of such obligations, services and/or duties and to pay the costs thereof in accordance with whatever contractual arrangement the Board of Directors of the Association shall enter in its sole discretion.

(l) To operate, maintain and manage the Surface Management System in a manner consistent with the Water Management District requirements and applicable District rules, and shall assist in the enforcement of the restrictions and covenants contained in the Declaration.

(m) To establish, maintain, operate and use reserve funds for capital improvements, repairs and replacements. To establish, maintain, operate and use reserve funds for items, services, property and/or any other purpose as the Board of Directors of the Association may determine in its sole discretion to be in the best interest of the Association.

(n) To enter into a management contract with a third party for the maintenance and repair of any Common Property and for the operation of the Association. The Board of Directors will carry out this power on behalf of the Association. The management contract may provide a management fee to the management agent and the delegation of certain duties, as may be determined by the Board of Directors of the Association.

(o) To enter into agreements and/or contracts with professionals, including but not limited to attorneys and accountants, to assist the Association in its performance of the obligations, services and duties required of or to be performed by the Association. The Board of Directors will carry out this power on behalf of the Association.

MAXIMUM\_1

COPY H06000267385

Nov. 2. 2006 4:58PM

No. 0319 P. 6  
H06000267385

**CO COPY**

(s) To create, appoint and/or dissolve any committees that the Board of Directors of the Association may deem appropriate.

(t) To collect delinquent assessments by fine, claim of lien, suit or otherwise and to file and defend any suit or other proceeding in pursuit of all legal and/or equitable remedies or defense of all claims relating to the Declaration, the Bylaws, these Articles of Incorporation and/or Florida law.

(u) To adopt, change, repeal and/or amend the Bylaws.

(v) To adopt, change, repeal and/or amend Bylaws that would be effective only in an emergency, as defined in Article XIII of these Articles of Incorporation.

**ARTICLE VI**

**MEMBERSHIP**

**Section 1.** Each Owner (including Declarant) shall be a Member of the Association. Membership in the Association shall be appurtenant to and inseparable from the Lot giving rise to such membership, and any transfer of record title to a Lot shall operate automatically to transfer to the new Owner the membership in the Association appurtenant to that Lot. The interest, if any, of a Member in the funds and assets of the Association may not be assigned, hypothecated or transferred in any manner, except as an appurtenance to that Member's Lot. Membership in the Association is mandatory for all Owners and membership shall continue, as to each Member, until such time as such Member transfers or conveys his fee simple interest in the Lot upon which his or her membership is based or until such fee simple interest is transferred or conveyed by operation of law, at which time the membership in the Association will automatically pass to the grantee or transferee. Notwithstanding the foregoing, the Association shall not be obligated to recognize such a transfer or conveyance of membership until such time as the Association receives a true copy of the recorded deed or other written instrument establishing the transfer or conveyance of ownership of the Lot, and it shall be the responsibility and obligation of the new Owner of the Lot to provide such true copy of said recorded instrument to the Association.

**Section 2.** The Association shall have two (2) classes of membership with the voting rights as follows:

(a) **Class A.** Class A Members shall be all the Owners of Lots, with the exception of Declarant for so long as Declarant retains Class B Voting Rights. Each Class A Member shall have one (1) vote for each Lot owned by that Member. When more than one person is an Owner of any Lot, all such persons shall be Members, but there shall not be more than one (1) vote for each Lot.

(b) **Class B.** The Class B Member shall be the Declarant or its express assigns or successors in interest. Until conversion of the Class B membership to Class A membership as

JAN060201\_1

**CO COPY**

H06000267385

Nov. 2. 2006 4:58PM

No. 0319 P. 7  
H06000267385

set forth in Article VI, Section 2(o) of these Articles of Incorporation, Declarant shall have ten (10) votes for each Lot owned by Declarant.

(c) **Conversion of Class B Membership.** Declarant's Class B membership shall continue in effect during the period from the date of the Declaration until the earlier of the following events:

(1) Three (3) months after ninety percent (90%) of all Lots in all phases of CountryWalk have been conveyed or transferred to Owners other than Declarant, excluding conveyances and/or transfers to builders, contractors, and/or others who purchase a Lot for the purpose of constructing improvements thereon for resale; or

(2) At such earlier time as Declarant, in its sole discretion, may so elect by recording a notice of such election in the Public Records of St. Johns County, Florida.

All votes shall be exercised or cast in the manner provided by the Declaration and Bylaws. After Turnover, the Class A Members may vote to elect the majority of the members of the Board. For the purposes of this Article, builders, contractors or others who purchase a Lot for the purpose of the constructing improvements thereon for resale shall not be deemed to be Class A Members. After Turnover, for so long as the Developer holds for sale in the ordinary course of business at least five percent (5%) of the Lots within the Property, the Developer may elect at least one (1) Director. After Turnover, the Developer will be a Class A Member with respect to the Lots which it owns and shall have all rights and obligations of a Class A Member, except that it may not cast its votes for the purpose of reacquiring control of the Association.

At Turnover, the Developer shall transfer control of the Association to Owners other than the Developer by causing enough of its appointed Directors to resign, whereupon it shall be the affirmative obligation of Owners other than the Developer to elect Directors and assume control of the Association. Provided at least thirty (30) days notice of Developer's decision to assume its appointment to resign is given to Owners, neither the Developer, nor such appointees, shall be liable in any manner in connection with such resignations even if the Owners other than the Developer refuse or fail to assume control.

(d) **No Split Votes.** The vote for each Lot must be cast as a single vote, and fractional votes shall not be allowed. If a Lot is owned by more than one (1) Owner, and the Owners of that Lot are unable to agree among themselves as to how the vote is to be cast, or if more than one (1) Class A vote is cast for any Lot, the vote for that Lot shall not be counted for any purpose except for establishing a quorum. If any Owner casts a vote on behalf of a Lot, it shall be conclusively presumed that Owner was acting with the authority and consent of all other Owners of that Lot.

(e) **Voting by Proxy.** All Members entitled to vote may do so by proxy. Any proxy shall be delivered to the Secretary of the Association's Board of Directors or another authorized person so designated by the Board of Directors. No proxy shall be valid after ninety (90) days from the date the proxy is signed by the Member. Every proxy shall be revocable at any time in the discretion of the Member executing that proxy.

JANU2006\_1

H06000267385

COPY

Nov. 2. 2006 4:58PM

No. 0319 P. 8  
H06000267385

**COOPY**

(3) **No Cumulative Voting.** There shall be no cumulative voting on any issue, matter or candidate that is the subject of a vote by the Association's membership.

(g) **Percentage of Members.** When reference is made in these Articles of Incorporation or the Bylaws to a majority or specific percentage of Members, such reference shall be deemed to be a reference to a majority or specific percentage of the votes of Members Entitled To Vote and not of the Members themselves.

**ARTICLE VII  
BOARD OF DIRECTORS**

The affairs of the Association shall be managed and administered by a Board of Directors consisting of either three (3) or five (5) members, as may be determined from time to time by the Association's Members Eligible To Vote. While Class B membership exists, the Board of Directors shall consist of three (3) members. All of the duties, power and authority of the Association existing under Florida law, the Declaration, these Articles and/or the Bylaws shall be exercised exclusively by the Board of Directors, subject to approval by the Members only when specifically required. The names and addresses of persons who are to act in the capacity of Director until appointment or election of their successors are:

**NAME**

**ADDRESS**

William B. Towers, III

6215 Wilson Boulevard  
Jacksonville, Florida 32210

Elizabeth F. Towers

6215 Wilson Boulevard  
Jacksonville, Florida 32210

Linda J. Richardson

6215 Wilson Boulevard  
Jacksonville, Florida 32210

**COOPY**

Any other provision of these Articles notwithstanding, the Declarant shall be entitled to appoint and remove any Director while Class B membership exists. When Class B membership terminates, the Class A Member Eligible To Vote shall elect Directors by written ballot at a Special Meeting of the Association's Members. A Member must be current in the payment of all Association Assessments to be eligible to run for and hold the position of Director. Directors must be natural persons who are eighteen (18) years of age or older. All Directors, except those designated or appointed by the Declarant, shall be Members of the Association.

Any vacancies on the Board shall be filled as set forth in the Bylaws of the Association.

**COOPY**

Nov. 2. 2006 4:59PM

No. 0319 P. 9 :  
H06000267385

**ARTICLE VIII**

**OFFICERS**

The officers of the Association may include a President, a Vice President, a Secretary, a Treasurer and such other officers as the Board of Directors may from time to time by resolution create. The officers shall be elected by the Board of Directors and the officers shall serve at the pleasure of the Board of Directors. The names and addresses of the officers who shall serve until their successors are designated by the Board of Directors are as follows:

<u>OFFICE</u>	<u>NAME</u>	<u>&amp;</u>	<u>ADDRESS</u>
<b>PRESIDENT:</b>	William B. Towers, III		6215 Wilson Boulevard Jacksonville, Florida 32210
<b>VICE PRESIDENT:</b>	Elizabeth F. Towers		6215 Wilson Boulevard Jacksonville, Florida 32210
<b>SECRETARY/TREASURER:</b>	Linda J. Richardson		6215 Wilson Boulevard Jacksonville, Florida 32210

**ARTICLE IX**

**INDEMNIFICATION OF OFFICERS AND DIRECTORS**

**Section 1.** The Association shall defend, indemnify and hold harmless any person of the Association who is made a party or is threatened to be made a party to any threatened, pending, or contemplated action, suit or proceedings, whether civil, criminal, administrative, or investigative, by reason of the fact that he is or was a Director, officer, Committee member, employee or agent of the Association:

(a) From and against expenses (including reasonable attorneys' fees for pretrial, trial, or appellate proceedings), judgments, fines, and amounts paid in settlement actually and reasonably incurred by him in connection with an action, suit, or proceeding (other than one by or in the right of the Association), if that person acted in good faith, and, with respect to any criminal action or proceedings, he or she had no reasonable cause to believe his or her conduct was unlawful; and

(b) From and against expenses (including reasonable attorneys' fees for pretrial, trial, or appellate proceedings) actually and reasonably incurred by him or her in connection with the defense or settlement of an action or suit by or in the right of the Association, if he or she acted in good faith.

2006022001\_1

H06000267385

COPY

Nov. 2. 2006 4:59PM

No. 0319 P. 10  
H06000267385

**Section 2.** The termination of any action, suit, or proceeding by judgment, order, settlement, conviction, or upon a plea of *nolo contendere* or its equivalent, shall not, of itself, create a presumption that the person did not act in good faith, or, with respect to any criminal action or proceeding, that such person had reasonable cause to believe that his or her conduct was unlawful.

**Section 3.** Notwithstanding any other provision hereof to the contrary, no indemnification shall be made in respect of any claim, issue, or matter as to which such person shall have been adjudged to be liable for gross negligence or misconduct in the performance of his duty to the Association.

**Section 4.** Any indemnification under Article IX, Section 1 of these Articles of Incorporation (unless ordered by a court) shall be made by the Association only as authorized in the specific case upon a determination that indemnification of the Director or officer, Committee member, employee or agent is proper in the circumstances because he or she has met the applicable standard of conduct set forth in Article IX, Section 1 of these Articles of Incorporation. Such determination shall be made (a) by the Board of Directors by a majority vote of a quorum consisting of Directors who were not parties to such action, suit, or proceeding, or (b) if such quorum is not obtainable, or, even if obtainable and a quorum of disinterested Directors so directs, by a majority vote of Members of the Association.

**Section 5.** Expenses incurred in defending a civil or criminal action, suit, or proceeding shall be paid by the Association from time to time as incurred rather than only after the final disposition of such action, suit, or proceeding. Payment of such expenses shall be authorized by the Board of Directors in each specific case only after receipt by the Association of an undertaking by or on behalf of the Director or officer to repay such amounts if it shall later develop that he or she is not entitled to be indemnified by the Association.

**Section 6.** The indemnification provided by this Article IX shall not be deemed exclusive of any other rights to which the Association's Directors, officers, Committee members, employees or agents may be entitled under the Association's Bylaws, agreement, vote of Members or disinterested Directors, or otherwise, both as to actions in their official capacities and as to actions in another capacity while holding such offices or positions, and shall continue as to a person who has ceased to be a Director, officer, Committee member, agent or employee and shall inure to the benefit of the heirs, executors and administrators of such a person.

**Section 7.** Notwithstanding the foregoing provisions, indemnification provided under this Article IX shall not include indemnification for any action of a Director, officer, Committee member, agent or employee of the Association for which indemnification is deemed to be against public policy. In the event that indemnification provided under this Article IX is deemed to be against public policy, such an event shall not invalidate or affect any other right or indemnification herein provided.

**Section 8.** The Association shall have the power, but shall not be obligated, to purchase and maintain indemnification insurance to provide coverage for any liability asserted against any Director, officer, Committee member, agent or employee of the Association in any of his or her

IAXN0201\_1

-9-

H06000267385

COPY

Nov. 2. 2006 4:59PM

No. 0319 P. 11  
H06000267383

capacities as described in Article IX, Section 1 of these Articles of Incorporation, whether or not the Association would have the power to indemnify him or her under this Article IX.

**Section 9.** Any person requesting indemnification shall first look to any insurance maintained by the Association for indemnification against expenses (including attorneys' fees), judgments, fines, and amounts paid in settlement (as described above). The Association shall be obligated to indemnify such person (if entitled to indemnification by the Association) only to the extent such insurance does not indemnify such person. In the event that any expenses, judgments, fines, or amounts paid in settlement are paid pursuant to insurance maintained by such Association, the Association shall have no obligation to reimburse the insurance company.

**ARTICLE X**

**EXISTENCE AND DURATION**

Existence of the Association shall commence with the filing of these Articles of Incorporation with the Secretary of State, Tallahassee, Florida and shall exist in perpetuity. Provided, however, in the event that the Association is dissolved, the assets shall be dedicated to the public body or conveyed to a non profit corporation with similar purpose. In the event of termination, dissolution or final liquidation of the Association, the responsibility for the operation and maintenance of the Surface Water Management System must be transferred to and accepted by an entity which would comply with Section 40C-42.027, F.A.C., and be approved by the Water Management District prior to such termination, dissolution or liquidation.

**ARTICLE XI**

**AMENDMENTS**

Amendments to these Articles of Incorporation shall be proposed and adopted as follows:

**Section 1.** Notice of a proposed amendment shall be included in the notice of any meeting at which the proposed amendment is to be considered and shall be otherwise given in the time and manner provided in Chapters 617 and 720, Florida Statutes. Such notice shall contain the proposed amendment or a summary of the changes to be effected thereby.

**Section 2.** Amendments shall be proposed and adopted in the manner provided in Chapters 617 and 720, Florida Statutes and in the Act (the latter to control over the former to the extent provided for in the Act); provided that in all events such amendments shall be approved by the Owners representing two thirds of the votes of the members of the Association who have voting power at the time of such amendment.

**Section 3.** Notwithstanding anything herein contained to the contrary, to the extent lawful, the Developer may amend these Articles consistent with the provisions of the Declaration allowing certain amendments to be effected by the Developer alone.

**Section 4.** A copy of each amendment shall be filed with the Secretary of State pursuant to the provisions of applicable Florida law, and a copy certified by the Secretary of

JX102501

**COPY** H06000267383

Nov. 2. 2006 5:00PM

No. 0319 P. 12  
H06000267385

State shall be recorded in the public records of St. Johns County, Florida with an identification on the first page thereof of the book and page of said public records where the Declaration are recorded which contains, as an exhibit, the initial recording of these Articles.

COPY

**ARTICLE XII**

**BYLAWS**

The Bylaws of the Association shall be initially adopted by a majority vote of the Association's Board of Directors and may subsequently be altered, amended, repealed and/or rescinded in the manner provided in the Bylaws.

**ARTICLE XIII**

**EMERGENCY BYLAWS**

The Association's Board of Directors, by majority vote, may adopt Bylaws that would be effective only in an emergency. For purposes of these Articles of Incorporation, "emergency" shall be defined as a catastrophic event that would prevent a quorum of the Association's Board of Directors from readily assembling, which would include but is not limited to the following: hurricanes; a declared state of emergency by the appropriate governmental agencies; and an evacuation ordered by the appropriate governmental agencies.

Any emergency Bylaws adopted by the Association's Board of Directors shall cease to be effective once the reason for the emergency ends. All provisions of the regular Bylaws that do not conflict with the emergency Bylaws remain effective during the emergency.

COPY

**ARTICLE XIV**

**CONFLICT BETWEEN DOCUMENTS**

In the event of any conflict or inconsistency between these Articles of Incorporation and the Declaration, the terms, conditions and provisions of the Declaration shall control and prevail. In the event of any conflict or inconsistency between these Articles of Incorporation and the Bylaws, the terms, conditions and provisions of these Articles of Incorporation shall control and prevail.

JAX100301

COPY

H06000267385

Nov. 2. 2006 5:00PM

No. 0319 P. 13  
H06000267385

**ARTICLE XVI**

**MERGER**

**Section 1.** The Association may be merged with any other Florida not-for-profit or for profit corporation, as long as the surviving corporation is a Florida not-for-profit corporation and has as one of its purposes to administer, enforce and carry out the terms, conditions, restrictions and provisions of the Declaration as it may be amended and/or supplemented from time to time, any subsequent Declaration, any restrictive covenants that run with the land and/or any equitable servitudes that may apply to the Property.

**Section 2.** In order for a merger to occur, the Association must adopt a plan of merger that contains at a minimum the following: the names of the corporations proposing to merge and the name of the surviving corporation which will be left following the merger; the terms and conditions of the proposed merger; a statement of any changes in the articles of incorporation of the surviving corporation to be affected by the merger; and a prohibition on any abandonment of the proposed merger after the merger has been approved by the Association's members pursuant to Article XVI, Section 3(c) of these Articles of Incorporation, unless such abandonment is first approved by the Association's members.

**Section 3.** In order to approve a plan of merger:

(a) the Board of Directors, by a majority vote, must first adopt a resolution approving the proposed plan of merger and then submit that plan of merger to a vote of the Association's membership by written notice.

(b) the written notice of the content of the proposed plan of merger must be given to all members of the Association at least fourteen (14) days prior to the date of the meeting when the vote on the proposed plan of merger will take place. In addition to the content of the proposed plan of merger, the Association shall provide the date, time and location for the meeting where the vote will take place. For purposes of Article XVI, Section 3(b) of these Articles of Incorporation, the notice will be considered to have been properly sent to the Association's membership when personally delivered or mailed, postage prepaid, by the Association, its employees, agents, Officers or Directors, to the address of the person who appears as a Member or Owner on the official records of the Association at the time of such delivery or mailing.

(c) the proposed plan of merger must then be approved by at least a majority of the Association's members, voting either in person or by proxy, at a duly called meeting of the Association's members at which a quorum is attained. This meeting of the Association's members may be either the annual meeting or a special meeting.

JAX0102801J

H06000267385

COPY

Nov. 2. 2006 5:00PM

No. 0319 P. 14  
H06000267385

ARTICLE XVII

INCORPORATOR

The name and street address of the Incorporator to these Articles of Incorporation are as follows:

NAME

ADDRESS

William B. Towers, III 6215 Wilson Blvd.  
Jacksonville, Florida 32210

COPY

IN WITNESS WHEREOF, for the purpose of forming this corporation under the laws of the State of Florida, the undersigned, constituting the Incorporator of this Association, has executed these Articles of Incorporation this 1st day of November, 2006.

*[Handwritten Signature]*

STATE OF FLORIDA  
COUNTY OF DUVAL

The foregoing Articles of Incorporation were acknowledged before me this 1st day of November, 2006, by William B. Towers, III who  is personally known to me OR  has produced \_\_\_\_\_ as identification.

NOTARY STAMP:



*Daniel Williamson*  
NOTARY PUBLIC, State of Florida

Print Name: \_\_\_\_\_  
Commission No. \_\_\_\_\_  
My Commission Expires: \_\_\_\_\_

COPY

JACK1002301\_1

H06000267385

COPY

Nov. 2. 2006 5:01PM

No. 0319 P. 15  
HD6000267385

**CERTIFICATE DESIGNATING REGISTERED AGENT  
FOR SERVICE OF PROCESS**

Pursuant to Chapters 48 and 617 of the Florida Statutes, the following is submitted in compliance with said Acts:

**COUNTRYWALK OWNERS ASSOCIATION, INC.**, desiring to organize as a corporation under the laws of the State of Florida, with its registered office at 6215 Wilson Boulevard, Jacksonville, Florida 32210, has named Linda J. Richardson, located at the above-registered office, as its Registered Agent to accept service of process within the State of Florida.

**ACKNOWLEDGMENT**

Having been named to accept service of process for the above-stated corporation at the place designated in this Certificate, I hereby accept to act in this capacity and agree to comply with the provisions of said Acts relative to keeping open said office.

Registered Agent:

LINDA J. RICHARDSON

By: 

Dated: November 1, 2006

COPY

FILED  
06 NOV -3 PM 12: 27  
SECRETARY OF STATE  
TALLAHASSEE, FLORIDA

JAN106301J

HD6000267385

COPY

**EXHIBIT "C"**

**Association Bylaws**

COPY

COPY

COPY

**BYLAWS  
OF  
COUNTRYWALK OWNERS ASSOCIATION, INC.**

**COPY**  
A Corporation Not for Profit  
Under the Laws of the State of Florida  
**1  
DEFINITIONS**

All terms in these Bylaws shall have the meanings as set forth in the Declaration of Covenants, Conditions, Restrictions and Easements for Countrywalk.

**2  
BOOKS AND PAPERS**

2.1 The books, records and papers of the Association shall at all times, during reasonable business hours, be subject to the inspection of any Member of the Association.

**COPY**  
**3  
MEMBERSHIP**  
3.1 Membership of the Association is as set forth in Article 6 of the Articles of Incorporation of the Association.  
3.2 The rights of membership are subject to the payment of annual and special assessments levied by the Association, the obligation of which assessments is imposed against each Owner of, and becomes a lien upon, that portion of the Property against which such assessments are made as provided in the Declaration.

**4  
BOARD OF DIRECTORS**

4.1 After Transition as defined in Section 720.307, Florida Statutes, the Directors of the Association shall be elected at the annual meeting of the Members except as otherwise specified in the Articles of Incorporation. The election shall be decided by majority of votes cast either by Members present in person or by written ballots cast prior to or at the annual meeting. The election shall be valid notwithstanding whether there was a quorum at the meeting.

**COPY**

4.2 Any director (other than a director designated by the Declarant) may be removed from office at any time with or without cause by the affirmative majority vote of the Association membership cast at a meeting at which a quorum is present.

4.3 After Turnover, the first meeting of the duly elected Board of Directors, for the purposes of organization, shall be held immediately after the annual meeting of Members, provided the majority of the members of the Board elected be present. Any action taken at such meeting shall be by a majority of the whole Board. If the majority of the members of the Board elected shall not be present at that time, or if the directors shall fail to elect officers, the meeting of the Board to elect officers shall then be held within thirty (30) days after the annual meeting of Members upon three (3) days notice in writing to each member of the Board so elected, stating the time, place and object of such meeting.

4.4 Subject to the provisions of Section 4.6 below, regular meetings of the Board of Directors may be held at any place or places in Florida as designated by the Board, on such days and at such hours as the Board of Directors may, by resolution, designate.

4.5 Subject to the provisions of Section 4.6 below, special meetings of the Board of Directors may be called at any time by the President or by any two (2) members of the Board and may be held any place or places within Florida as designated by the Board, and at any time.

4.6 Except only for meetings between the Board and its attorney with respect to proposed or pending litigation where the contents of the discussion would otherwise be protected by the attorney-client privilege, regular and/or special meetings of the Board of Directors shall be open to all Owners, and notices of Board meetings shall be posted in a conspicuous place on the property governed by the Association at least forty eight (48) hours prior to the meeting, except in the event of an emergency. In the alternative, if notice is not conspicuously posted, notice of the Board meeting must be mailed or delivered to each Member at least seven (7) days before the meeting, except in an emergency. Notwithstanding this general notice requirement, notice of any meeting in which assessments against Lots or Units are to be considered shall specifically contain a statement to that effect as well as a statement of the nature of such assessments and shall be provided to each Owner not less than fourteen (14) days prior to the meeting.

4.7 Directors (including affiliates of the Declarant) shall have the absolute right to resign at any time and the remaining directors in office shall then fill the vacancies, provided that if all directors resign, a special meeting of Members shall be called as soon as possible for the purpose of electing new directors and the resignations of such directors shall not be effective until such election is held and new directors are elected, except that if no meeting is held or no directors are elected after two (2) attempts to call and hold such meeting, the resignations shall become effective simultaneously with the date and time of the scheduled second meeting, whether held or not or whether new directors are elected or not. Notwithstanding anything herein contained to the contrary, in the event that a Director appointed by the Declarant resigns, said seat shall be filled by a replacement designated by the Declarant rather than by the remaining directors.

4.8 Directors may not vote by proxy or secret ballot, provided, however, that secret ballots may be used for the election of officers. This subsection also applies to the meetings of any committee or other similar body, when a final decision will be made regarding the

JAX1107208-1

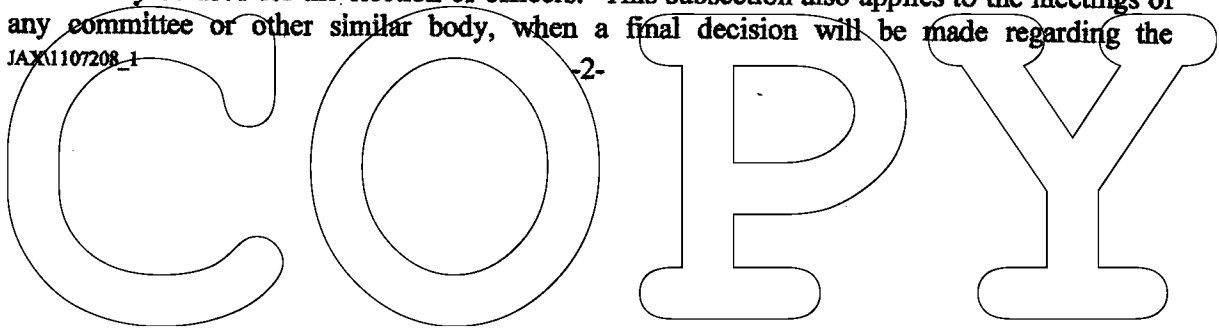

expenditure of association funds, and to any body vested with the power to approve or disapprove architectural decisions with respect to a specific parcel of residential property owned by a member of the community.

4.9 The Directors of the Association have a fiduciary duty to the Owners of Lots or Units governed by the Association.

4.10 Members have the right to attend all meetings of the board and to speak on any matter placed on the agenda by petition of the voting interests for at least 3 minutes. The Association may adopt written reasonable rules expanding the right of members to speak and governing the frequency, duration, and other manner of member statements, which rules must be consistent with this paragraph and may include a sign-up sheet for members wishing to speak. Notwithstanding any other law, the requirement that board meetings and committee meetings be open to the members is inapplicable to meetings between the board or a committee and the association's attorney, with respect to meetings of the board held for the purpose of discussing personnel matters.

4.11 If 20 percent of the total voting interests petition the board to address an item of business, the board shall at its next regular board meeting or at a special meeting of the board, but not later than 60 days after the receipt of the petition, take the petitioned item up on an agenda. The board shall give all members 14 days notice of the meeting at which the petitioned item shall be addressed. Each member shall have the right to speak for at least 3 minutes on each matter placed on the agenda by petition, provided that the member signs the sign-up sheet, if one is provided, or submits a written request to speak prior to the meeting. Other than addressing the petitioned item at the meeting, the board is not obligated to take any other action requested by the petition.

**5**  
**RECALL OF DIRECTORS**

5.1 Subject to the provisions of s. 720.307 regarding transition of association control, any member of the board or directors may be recalled and removed from office with or without cause by a majority of the total voting interests in accordance with the provisions of Section 720.303 (10) Florida Statutes.

**6**  
**OFFICERS**

6.1 Any officer may be removed at any time by the affirmative vote of a majority of the Board of Directors at any duly called regular or special meeting of the Board.

6.2 The President shall be the chief executive officer of the Association. The President shall preside at all meetings of the Members of the Association and of the Board of Directors. He shall have the general powers and duties of supervision and management of the Association which usually pertain to his office, and shall perform all such duties as are properly required of him by the Board of Directors. The Board of Directors shall elect at least one (1) Vice President, who shall have such powers and perform such duties as usually pertain to such office or as are

**3**  
**COPY**

properly required of him by the Board of Directors. In the absence or disability of the President, any Vice President shall perform the duties and exercise the powers of the President. If more than one (1) Vice President is elected, the Board shall designate which Vice President is to perform which duties. The Secretary shall issue notices of all meetings of the membership of the Association and the directors where notices of such meetings are required by law or in these Bylaws. He shall keep the minutes of the meetings of the membership and of the Board of Directors. The Treasurer shall have the care and custody of all the monies and securities of the Association. He shall enter on the books of the Association, to be kept by him for that purpose, full and accurate accounts of all monies received by him and paid by him on account of the Association. He shall sign such instruments as require his signature and shall perform all such duties as usually pertain to his office or as are properly required of him by the Board of Directors.

6.3 Vacancies in any office arising from any cause may be filled by the Board of Directors at any regular or special meeting.

6.4 The officers of the Association have a fiduciary duty to the Owners of Lots governed by the Association.

7

**MEETINGS OF MEMBERS**

7.1 The regular annual meeting of the Members shall be held in the month of November in each year at such time and place as shall be determined by the Board of Directors. The election of directors shall be held at, or in conjunction with, the annual meeting.

7.2 Special meetings of the Members for any purpose may be called at any time by the President, the Vice President, the Secretary or Treasurer, or by any two (2) or more members of the Board of Directors, or upon written request of the Members who have a right to vote 10% of all the votes of the entire membership, or who have a right to vote 10% of the votes of the Class A membership. Business conducted at a special meeting shall be limited to the purposes set forth in the notice of meeting.

7.3 Notice may be given to the Members either personally, or by sending a copy of the notice through the mail, postage thereon fully paid, to the addresses appearing on the records of the Association. Each Member shall register his address with the Secretary, and notices of meetings shall be mailed to him at such address. Notice of any meeting, regular or special, shall be mailed or personally delivered at least fourteen (14) days in advance of the meeting and shall set forth the general nature of the business to be transacted, provided, however, that if any business of any meeting shall involve any action governed by the Articles of Incorporation, notice of such meeting shall be given or sent as therein provided.

7.4 The presence in person or by proxy at the meeting of Members entitled to cast at least 30% of the votes of the membership shall constitute a quorum for any action governed by these Bylaws. Unless a greater percentage is expressly required, decisions of the members shall be made by a majority of the voting interests represented at a meeting at which a quorum is present.

JAX1107208\_1

-4-

**COPY**

7.5 Members have the right to vote in person or by proxy. To be valid, a proxy must be in writing and be signed by the Member and the proxy must state the date, time and place of the meeting for which it was given. A proxy is effective only for the meeting for which it was given, as the meeting may be legally adjourned and reconvened from time to time, and automatically expires ninety (90) days following the date of the meeting for which it was originally given. A proxy is revocable at any time at the pleasure of the person who executes it. If the proxy form so provides, the proxy holder may appoint, in writing, a substitute to act in the proxy holder's place.

7.6 Any Owner may tape record or videotape meetings of the Members, subject however to the rules established from time to time by the Board regarding such tapings.

7.7 Except when specifically or impliedly waived by the chairman of a meeting (either of Members or Directors) Roberts Rules of Order (latest edition) shall govern the conduct of Association meetings when not in conflict with the Declaration the Articles or these Bylaws; provided, however, that a strict or technical reading of said Roberts' Rules of Order shall not be made as to frustrate the will of the persons participating in said meeting.

8

AMENDMENTS

8.1 These Bylaws may be amended, at a regular or special meeting of the Board, by a vote of two thirds of the votes of the Directors, provided that the notice to the Members of the meeting discloses the information that the amendment of the Bylaws is to be considered, provided, however, the provisions which are governed by the Articles of Incorporation of this Association may not be amended except as provided in the Articles of Incorporation or applicable law; and provided further that any matters stated herein to be or which are in fact governed by the Declaration may not be amended except as provided in such Declaration. Anything to the contrary herein notwithstanding, the Declarant shall have the absolute right to amend these Bylaws and the Articles of Incorporation prior to the Transition of Control to the members as provided in Section 720.307, Florida Statutes.

8.2 In case of any conflict between the Articles of Incorporation and these Bylaws, the Articles shall control; and in case of any conflict between the Declaration and these Bylaws, the Declaration shall control.

8.3 So long as there is a Class B Membership, all amendments to the Bylaws shall be approved by the Federal Housing Agency ("FHA") or the Veteran's Administration ("VA").

9

OFFICIAL RECORDS

From the inception of the Association, the Association shall maintain each of the following, where applicable, which shall constitute the official records of the Association:

- (a) A photocopy of any plans, specifications, permits and warranties related to improvements constructed on the Common Property or other property that the Association is obligated to maintain, repair or replace;

JAX1107208\_1

-5-

COPY

- (b) A photocopy of the Bylaws of the Association and all amendments thereto;
- (c) A certified copy of the Articles of Incorporation of the Association or other documents creating the Association and all amendments thereto;
- (d) A photocopy of the Declaration and all amendments thereto;
- (e) A copy of the current Rules and Regulations of the Association;
- (f) The minutes of all meetings of the Association, of the Board of Directors, and of Members, which minutes shall be retained for a period of not less than 7 years;
- (g) A current roster of all Owners, their mailing addresses and Lot or Unit identifications;
- (h) All current insurance policies of the Association or a copy of each such policy, which policies shall be retained for a period of not less than 7 years;
- (i) A current copy of all contracts to which the Association is a party, including, without limitation, any management agreement, lease, or other contract under which the Association has an obligation or responsibility;
- (j) Bids received by the Association for any work to be performed on behalf of the Association, which bids shall be retained for a period of not less than 1 year;
- (k) All other written records of the association not specifically included in the foregoing which are related to the operation of the association.
- (l) Financial and accounting records for the Association maintained in accordance with good accounting practices. All financial and accounting records shall be maintained for a period of not less than 7 years. The financial and accounting records shall include, but not be limited to:
  - (i) Accurate, itemized, and detailed records for all receipts and expenditures;
  - (ii) A current account and a periodic statement of the account for each Member of the Association, designating the name and current address of each Member, the due date and amount of each Assessment, the date and amount of each payment on the account, and the balance due;
  - (iii) All tax returns, financial statements and financial records of the Association; and
  - (iv) Any other records that identify, measure, record or communicate financial information.

COPY

Notwithstanding the provisions of this paragraph, the following records shall not be accessible to members or parcel owners:

(1) Any record protected by the lawyer-client privilege as described in s. 90.502 and any record protected by the work-product privilege, including, but not limited to, any record prepared by an association attorney or prepared at the attorney's express direction which reflects a mental impression, conclusion, litigation strategy, or legal theory of the attorney or the association and was prepared exclusively for civil or criminal litigation or for adversarial administrative proceedings or which was prepared in anticipation of imminent civil or criminal litigation or imminent adversarial administrative proceedings until the conclusion of the litigation or adversarial administrative proceedings.

(2) Information obtained by an association in connection with the approval of the lease, sale, or other transfer of a parcel.

(3) Disciplinary, health, insurance, and personnel records of the association's employees.

(4) Medical records of parcel owners or community residents.

10

**BOOKS AND PAPERS: FISCAL YEAR;  
MINUTES: BUDGETS: FINANCIAL REPORTS**

10.1 The official records shall be maintained within the State of Florida and must be open to inspection and available for photocopying by any Association Member or the authorized agent(s) of such Member at all reasonable times and places within ten (10) business days after receipt of a written request for access. The Association may adopt reasonable written rules regarding the frequency, time, location, notice and manner of inspections and may impose fees to cover the costs of providing copies of the official records, including, without limitation, the costs of copying but may not impose a requirement that a parcel owner demonstrate any proper purpose for the inspection, state any reason for the inspection, or limit a parcel owner's right to inspect records to less than one 8-hour business day per month. The association may charge up to 50 cents per page for copies made on the association's photocopier. If the association does not have a photocopy machine available where the records are kept, or if the records requested to be copied exceed 25 pages in length, the association may have copies made by an outside vendor and may charge the actual cost of copying. If the association has a photocopy machine available where the records are maintained, it must provide parcel owners with copies on request during the inspection if the entire request is limited to no more than 25 pages. The Association shall maintain an adequate number of copies of the recorded Declaration, Articles, Bylaws and any rules to ensure their availability to Members and prospective Members, and may charge only its actual costs for reproducing and furnishing these documents.

10.2 The fiscal year of the Association shall be the twelve-month period commencing January 1st and terminating December 31st of each year.

JAX11107208 1

-7-

COPY

10.3 Minutes of all meetings of the Members and of the Board must be maintained in written form or in another form that can be converted into written form within a reasonable time. The vote or abstention from voting on each matter voted upon for each director present at a Board meeting must be recorded in the minutes.

10.4 The Association shall prepare an annual budget reflecting, among other things, the estimated revenues and expenses for the budgeted year and the estimated surplus or deficit for the end of the current year. The budget must separately set out all fees or charges for recreational amenities, whether owned by the Association or another person. The Association shall provide each Member with a copy of the annual budget or a written notice advising that a copy of the budget is available upon request at no charge to the Member. The copy must be provided to the Member in accordance with the time limits set forth in Section 9.1 above.

10.5 Financial reports shall be prepared as follows

(a) An association that meets the criteria of this paragraph shall prepare or cause to be prepared a complete set of financial statements in accordance with generally accepted accounting principles. The financial statements shall be based upon the association's total annual revenues, as follows:

1. An association with total annual revenues of \$100,000 or more, but less than \$200,000 shall prepare compiled financial statements.
2. An association with total annual revenues of at least \$200,000 but less than \$400,000 shall prepare reviewed financial statements.

3. An association with total annual revenues of \$400,000 or more shall prepare audited financial statements.

(b)

1. An association with total annual revenues of less than \$100,000 shall prepare a report of cash receipts and expenditures.

2. An association in a community of fewer than 50 parcels, regardless of the association's annual revenues, may prepare a report of cash receipts and expenditures in lieu of financial statements required by paragraph (a) unless the governing documents provide otherwise.

3. A report of cash receipts and disbursement must disclose the amount of receipts by accounts and receipt classifications and the amount of expenses by accounts and expense classifications, including, but not limited to, the following, as applicable: costs for security, professional, and management fees and expenses; taxes; costs for recreation facilities; expenses for refuse collection and utility services; expenses for lawn care; costs for building maintenance and repair; insurance costs; administration and salary expenses; and reserves if maintained by the association.

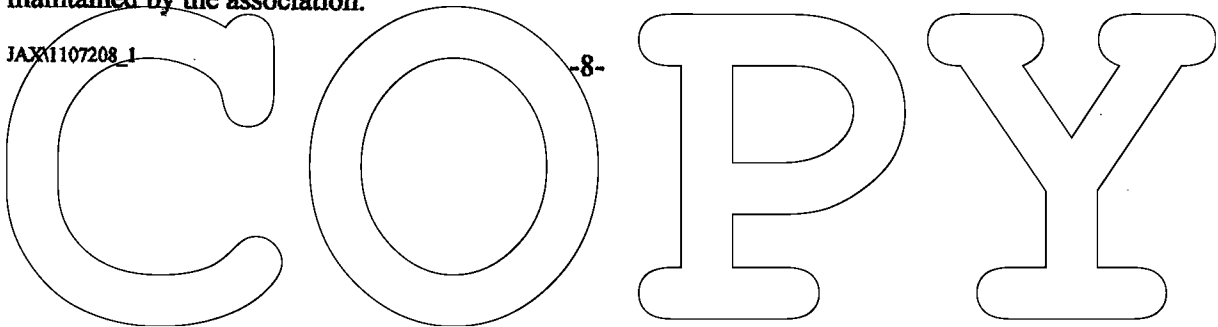

(c) If 20 percent of the parcel owners petition the board for a level of financial reporting higher than that required by this section, the association shall duly notice and hold a meeting of members within 30 days of receipt of the petition for the purpose of voting on raising the level of reporting for that fiscal year. Upon approval of a majority of the total voting interests of the parcel owners, the association shall prepare or cause to be prepared, shall amend the budget or adopt a special assessment to pay for the financial report regardless of any provision to the contrary in the governing documents, and shall provide within 90 days of the meeting or the end of the fiscal year, whichever occurs later:

1. Compiled, reviewed, or audited financial statements, if the association is otherwise required to prepare a report of cash receipts and expenditures;
2. Reviewed or audited financial statements, if the association is otherwise required to prepare compiled financial statements; or
3. Audited financial statements if the association is otherwise required to prepare reviewed financial statements.

(d) If approved by a majority of the voting interests present at a properly called meeting of the association, an association may prepare or cause to be prepared:

1. A report of cash receipts and expenditures in lieu of a compiled, reviewed, or audited financial statement;
2. A report of cash receipts and expenditures or a compiled financial statement in lieu of a reviewed or audited financial statement; or
3. A report of cash receipts and expenditures, a compiled financial statement, or a reviewed financial statement in lieu of an audited financial statement.

10.6 The Association shall prepare an annual financial report within sixty (60) days following the close of each fiscal year of the Association. The financial report must consist of either, at the determination of the Board, (a) financial statements presented in conformity with generally accepted accounting principles, or (b) a financial report of actual receipts and expenditures, cash basis, showing, the amount of receipts and expenditures by classification and the beginning and ending cash balances of the Association. The Association shall provide each Member with a copy of the annual financial report or a written notice advising that a COPY of the report is available upon request at no charge to the Member. The copy must be provided to the Member in accordance with the time limits set forth in Section 9.1 above.

As to the provisions of Section 10.5 and 10.6 above, any amendment to Section 720.303(6) and (7) shall automatically amend Section 10.5 and 10.6 so that the same remain consistent with Section 720.303 (6) and (7), Florida Statutes.

COPY

**11  
CONTRACTS**

All contracts as further described in this section or any contract that is not to be fully performed within 1 year after the making thereof for the purchase, lease, or renting of materials or equipment to be used by the association in accomplishing its purposes under this chapter or the governing documents, and all contracts for the provision of services, shall be in writing. If a contract for the purchase, lease, or renting of materials or equipment, or for the provision of services, requires payment by the association that exceeds 10 percent of the total annual budget of the association, including reserves, the association must obtain competitive bids for the materials, equipment, or services. Nothing contained in this section shall be construed to require the association to accept the lowest bid. Notwithstanding the foregoing, contracts with employees of the association, and contracts for attorney, accountant, architect, community association manager, engineering, and landscape architect services are not subject to the provisions of this section.

**12  
DISCLOSURE**

Owners shall comply with the disclosure requirements set forth in Part II of Chapter 720. The current requirements are set forth in Exhibit A to these Bylaws.

COPY

JAX1107208 1 -10- COPY

**Exhibit A  
DISCLOSURE**

**A PROSPECTIVE PARCEL OWNER IN A COMMUNITY MUST BE** presented a disclosure summary before executing the contract for sale. The disclosure summary must be in a form substantially similar to the following form:

**DISCLOSURE SUMMARY  
FOR  
COUNTRYWALK**

1. ~~AS A PURCHASER OF PROPERTY IN THIS COMMUNITY, YOU WILL BE OBLIGATED TO BE A MEMBER OF A HOMEOWNERS' ASSOCIATION.~~
2. THERE HAVE BEEN OR WILL BE RECORDED RESTRICTIVE COVENANTS GOVERNING THE USE AND OCCUPANCY OF PROPERTIES IN THIS COMMUNITY.
3. YOU WILL BE OBLIGATED TO PAY ASSESSMENTS TO THE ASSOCIATION. ASSESSMENTS MAY BE SUBJECT TO PERIODIC CHANGE. IF APPLICABLE, THE CURRENT AMOUNT IS \$ \_\_\_\_ PER \_\_\_\_ . YOU WILL ALSO BE OBLIGATED TO PAY ANY SPECIAL ASSESSMENTS IMPOSED BY THE ASSOCIATION. SUCH SPECIAL ASSESSMENTS MAY BE SUBJECT TO CHANGE. IF APPLICABLE, THE CURRENT AMOUNT IS \$ \_\_\_\_ PER \_\_\_\_ .
4. YOU MAY BE OBLIGATED TO PAY SPECIAL ASSESSMENTS TO THE RESPECTIVE MUNICIPALITY, COUNTY, OR SPECIAL DISTRICT. ALL ASSESSMENTS ARE SUBJECT TO PERIODIC CHANGE.
5. YOUR FAILURE TO PAY SPECIAL ASSESSMENTS OR ASSESSMENTS LEVIED BY A MANDATORY HOMEOWNERS' ASSOCIATION COULD RESULT IN A LIEN ON YOUR PROPERTY.
6. ~~THERE MAY BE AN OBLIGATION TO PAY RENT OR LAND USE FEES FOR RECREATIONAL OR OTHER COMMONLY USED FACILITIES AS AN OBLIGATION OF MEMBERSHIP IN THE HOMEOWNERS' ASSOCIATION. IF APPLICABLE, THE CURRENT AMOUNT IS \$ \_\_\_\_ PER \_\_\_\_ .~~
7. THE DEVELOPER MAY HAVE THE RIGHT TO AMEND THE RESTRICTIVE COVENANTS WITHOUT THE APPROVAL OF THE ASSOCIATION MEMBERSHIP OR THE APPROVAL OF THE PARCEL OWNERS.
8. THE STATEMENTS CONTAINED IN THIS DISCLOSURE FORM ARE ONLY SUMMARY IN NATURE, AND, AS A PROSPECTIVE PURCHASER, YOU SHOULD REFER TO THE COVENANTS AND THE ASSOCIATION GOVERNING DOCUMENTS BEFORE PURCHASING PROPERTY.

JAX1107208 1

**COPY**

9. THESE DOCUMENTS ARE EITHER MATTERS OF PUBLIC RECORD AND CAN BE OBTAINED FROM THE RECORD OFFICE IN THE COUNTY WHERE THE PROPERTY IS LOCATED, OR ARE NOT RECORDED AND CAN BE OBTAINED FROM THE DEVELOPER.

DATE:

PURCHASER:

PURCHASER:

COPY

The disclosure must be supplied by the developer, or by the parcel owner if the sale is by an owner that is not the developer. Any contract or agreement for sale shall refer to and incorporate the disclosure summary and shall include, in prominent language, a statement that the potential buyer should not execute the contract or agreement until they have received and read the disclosure summary required by this section.

(b) Each contract entered into for the sale of property governed by covenants subject to disclosure required by this section must contain in conspicuous type a clause that states:

IF THE DISCLOSURE SUMMARY REQUIRED BY SECTION 720.401, FLORIDA STATUTES, HAS NOT BEEN PROVIDED TO THE PROSPECTIVE PURCHASER BEFORE EXECUTING THIS CONTRACT FOR SALE, THIS CONTRACT IS VOIDABLE BY BUYER BY DELIVERING TO SELLER OR SELLER'S AGENT OR REPRESENTATIVE WRITTEN NOTICE OF THE BUYER'S INTENTION TO CANCEL WITHIN 3 DAYS AFTER RECEIPT OF THE DISCLOSURE SUMMARY OR PRIOR TO CLOSING, WHICHEVER OCCURS FIRST. ANY PURPORTED WAIVER OF THIS VOIDABILITY RIGHT HAS NO EFFECT. BUYER'S RIGHT TO VOID THIS CONTRACT SHALL TERMINATE AT CLOSING.

(c) If the disclosure summary is not provided to a prospective purchaser before the purchaser executes a contract for the sale of property governed by covenants that are subject to disclosure pursuant to this section, the purchaser may void the contract by delivering to the seller or the seller's agent or representative written notice canceling the contract within 3 days after receipt of the disclosure summary or prior to closing, whichever occurs first. This right may not be waived by the purchaser but terminates at closing.

COPY

**EXHIBIT "D"**

**Common Area**

The developer hereby designates all of the following tracts in CountryWalk, according to plat in Map Book 63, page 64, St. Johns County records, as Common Areas for the intended use, enjoyment, and maintenance by CountryWalk Owners Association, a Florida not for profit corporation.

Tracts A, D and S – Recreation Area

Tracts B and E – Open Space

Tract F – Possible Future Connection

Tracts G, H, I and J - Buffer Area

Tracts L, M, N and O – Conservation Area

Tracts P, Q and R – Landscaping / Signage

COPY

JAX\165338\_2 -43- COPY

CONSENT AND JOINDER OF DEVELOPER'S MORTGAGEE

The undersigned, CNL Bank, a Florida Banking Corporation (Developer's Mortgagee), the Mortgagee under that certain Mortgage, Security Agreement and Financing Statement dated October 31, 2005 as recorded at Official Records Book 2599, page 818-836, and amended on December 22, 2006, as recorded at Official Records Book 2851, page 357-361 all, in the public records of St. Johns County, Florida hereby consents and joins in and consents to the foregoing Declaration of Covenants, Conditions, Restrictions and Easements for CountryWalk, to evidence its consent to and joinder of said Declaration of Covenants, Conditions, Restrictions and Easements for CountryWalk.

IN WITNESS WHEREOF, this Consent and Joinder is executed by the undersigned this 30<sup>th</sup> day of October, 2007.

Witnesses:

Mortgagee

Sheri Huey  
Name: Sheri Huey

CNL BANK  
By: [Signature]  
Name: Lynn Vermilya  
Title: SENIOR VICE PRESIDENT

Christine A. Williams  
Name: Christine A. Williams

STATE OF FLORIDA  
COUNTY OF Duval

The foregoing instrument was acknowledged before me this 30<sup>th</sup> day of October, 2007, by Lynn Vermilya, the SVP of CNL Bank, a (select one)  who is personally known to me or  who has produced a Florida driver's license as identification.

Sheri Huey  
Notary Public, State of Florida  
Name: \_\_\_\_\_  
My Commission Expires: \_\_\_\_\_  
My Commission Number is: \_\_\_\_\_

JAX1165338\_2

 Sheri Huey  
My Commission DD257738  
Expires January 26, 2008

COPY

COPY

COPY

CONSENT AND JOINDER OF OWNER

The undersigned, Watson Custom Homebuilders, Inc., a Florida corporation (Owner), the Owner under that certain Special Warranty Deed dated 14 March 2007 as recorded at Official Records Book 2885, page 438, 355, 373, 1808, in the public records of St. Johns County, Florida hereby consents and joins in and consents to the foregoing Declaration of Covenants, Conditions, Restrictions and Easements for CountryWalk, to evidence its consent to and joinder of said Declaration of Covenants, Conditions, Restrictions and Easements for CountryWalk.

IN WITNESS WHEREOF, this Consent and Joinder is executed by the undersigned this 27 day of November, 2007.

Signed, sealed and delivered in the presence of:

“OWNER”

WATSON CUSTOM HOME BUILDERS, INC., a Florida corporation

Dianne Williamson  
Print Name Dianne Williamson

By: [Signature]  
Name: William B. Towers, Jr.  
Title: Vice President

Theresa M. Miller  
Print Name Theresa M. Miller

STATE OF FLORIDA  
COUNTY OF DUVAL

The foregoing instrument was acknowledged before me this 27<sup>th</sup> day of November, 2007, by William B. Towers, Jr., as Vice President of WATSON CUSTOM HOME BUILDERS, INC., a Florida corporation, on behalf of the corporation (select one)  who is personally known to me or  who has produced a Florida driver's license as identification.

Dianne Williamson  
Notary Public, State of Florida  
Name: \_\_\_\_\_

My Commission Expires  
My Commission Number is: \_\_\_\_\_

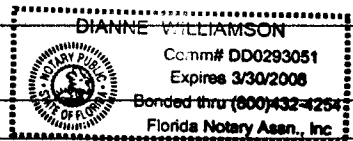

COPY

CONSENT AND JOINDER OF OWNER'S MORTGAGEE

The undersigned, FIDELITY BANK, a Georgia State Banking Association (Owner's Mortgagee), the Mortgagee under that certain Mortgage, Security Agreement and Financing Statement dated July 30, 2001 as recorded at Official Records Book 1830, page 89, and amended on March 14, 2007, as recorded at Official Records Book 2885, page 1810 all, in the public records of St. Johns County, Florida hereby consents and joins in and consents to the foregoing Declaration of Covenants, Conditions, Restrictions and Easements for CountryWalk, to evidence its consent to and joinder of said Declaration of Covenants, Conditions, Restrictions and Easements for CountryWalk.

IN WITNESS WHEREOF, this Consent and Joinder is executed by the undersigned this 5th day of November, 2007.

Witnesses:

Mortgagee

FIDELITY BANK, a Georgia State Banking Association

Tammy Simmons
Name: TAMMY SIMMONS

By: [Signature]
Name: Frazier Dughi
Title: Vice President

[Signature]
Name: DEBORAH D. BARBER

STATE OF FLORIDA
COUNTY OF DUVAL

The foregoing instrument was acknowledged before me this 5th day of November, 2007, by Frazier Dughi, as Vice President of FIDELITY BANK, a Georgia State Banking Association, on behalf of the association (select one) who is personally known to me or who has produced a Florida driver's license as identification.

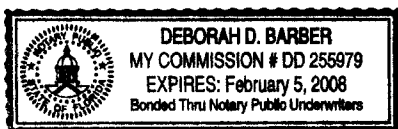

[Signature]
Notary Public, State of Florida
Name:
My Commission Expires:
My Commission Number is: